

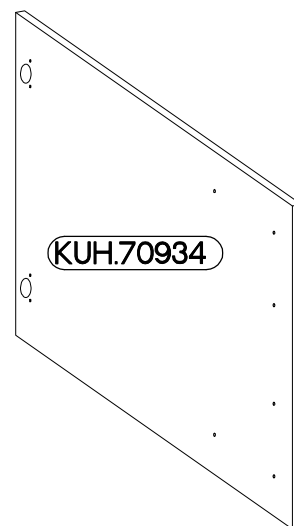

60 DPM-2100 2F
FRONT

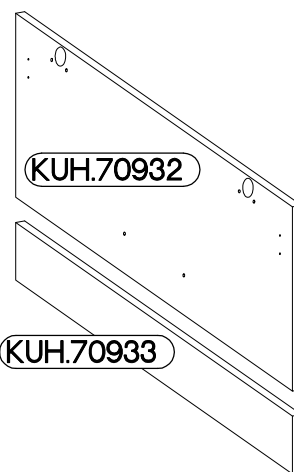
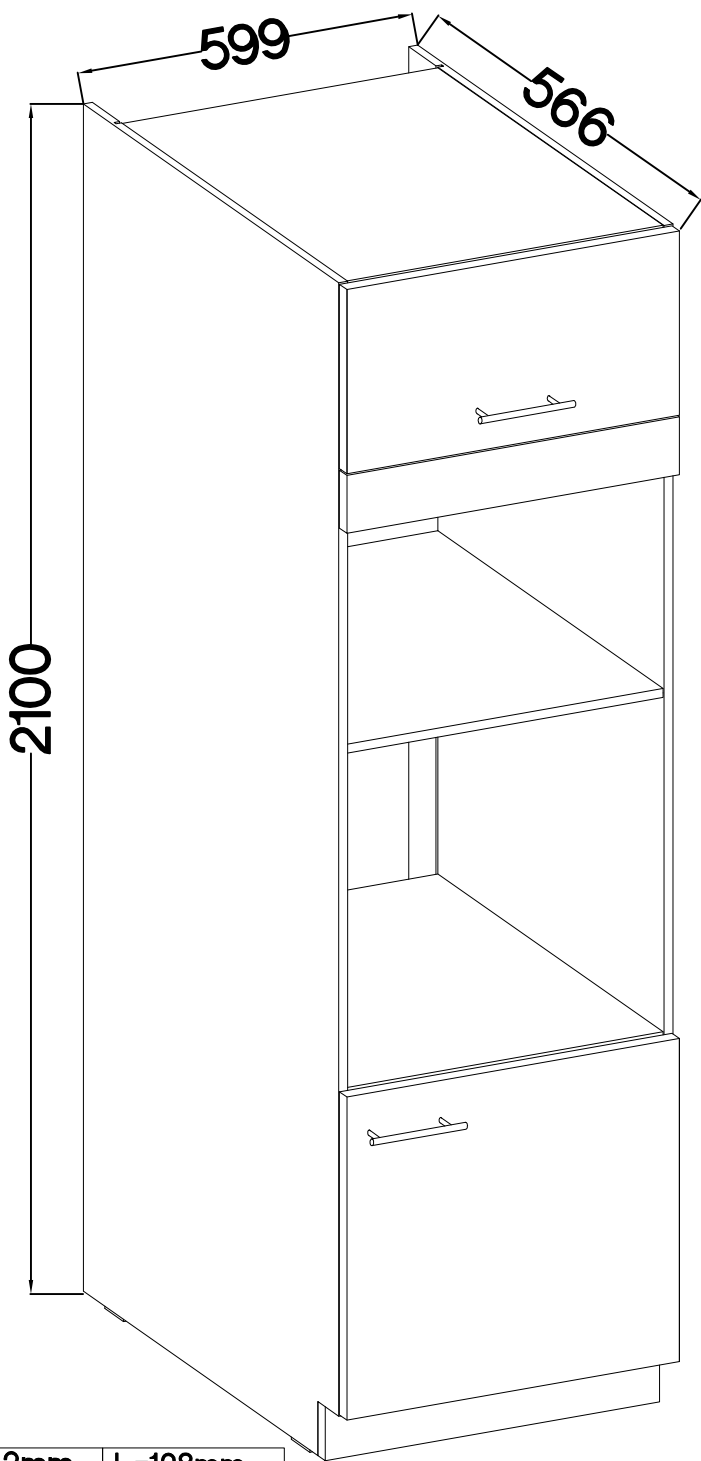
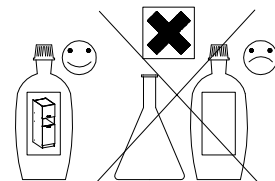
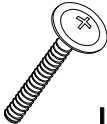

M4x22mm	L=128mm
	
U	S
4	2

ISM-KUH-01643





LEFT

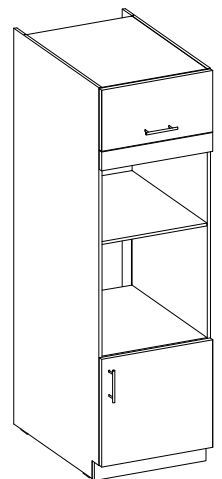
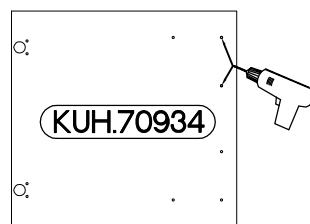
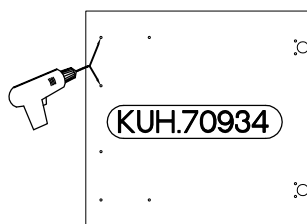
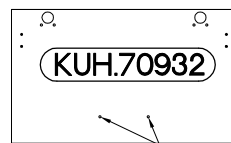
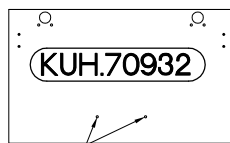
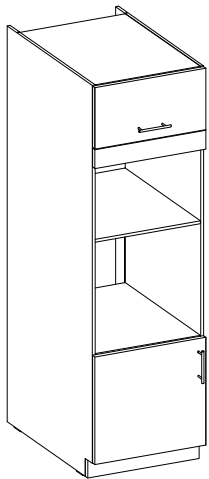
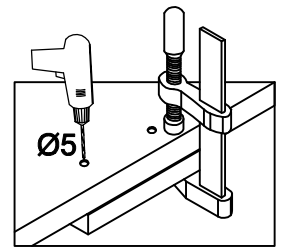
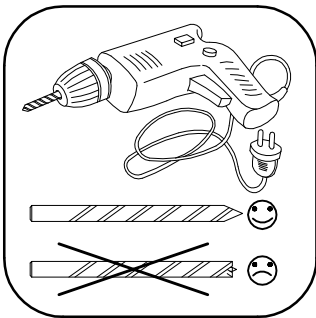
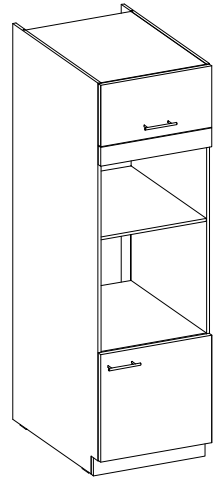
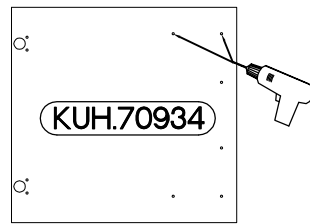
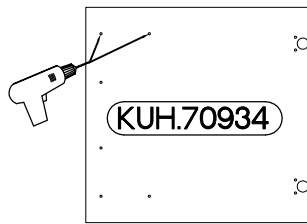
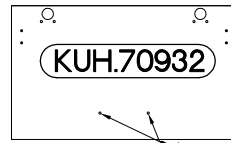
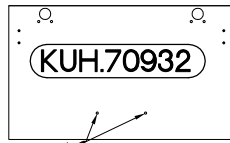
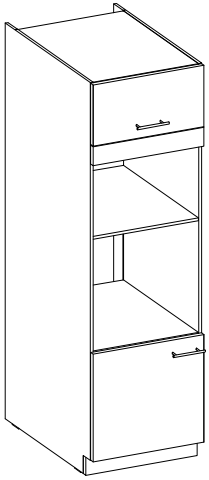

RIGHT



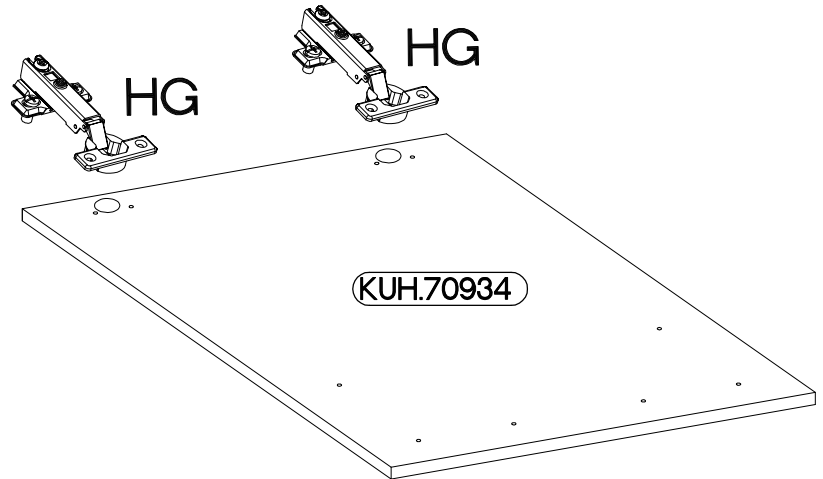
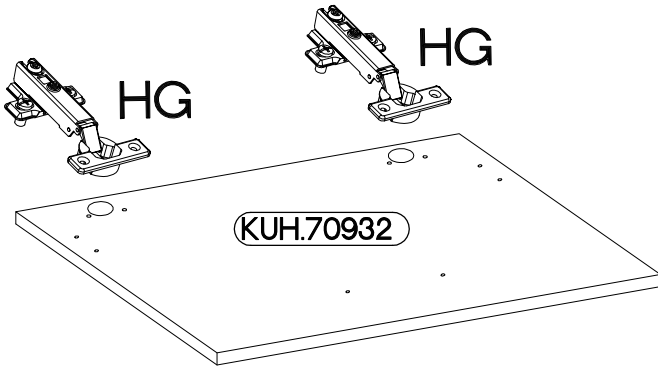
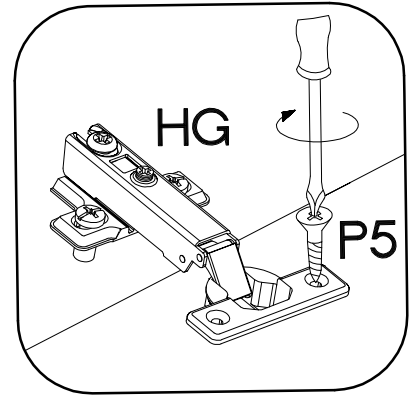

2

$\pm 35/0\text{mm}$  [CD] HG 4	$\pm 3.5 \times 13\text{mm}$  P5 8
---	---

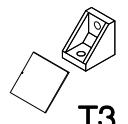

3

 T3 2	$\pm 4.0 \times 16\text{mm}$  P1 2
--	--

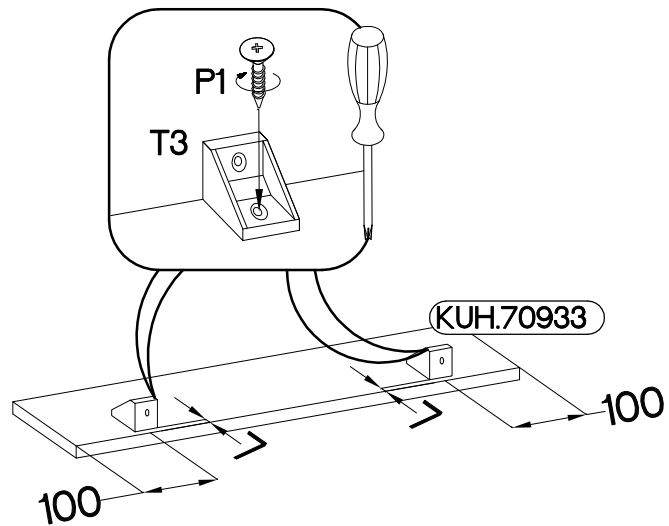

4

4.0x16mm

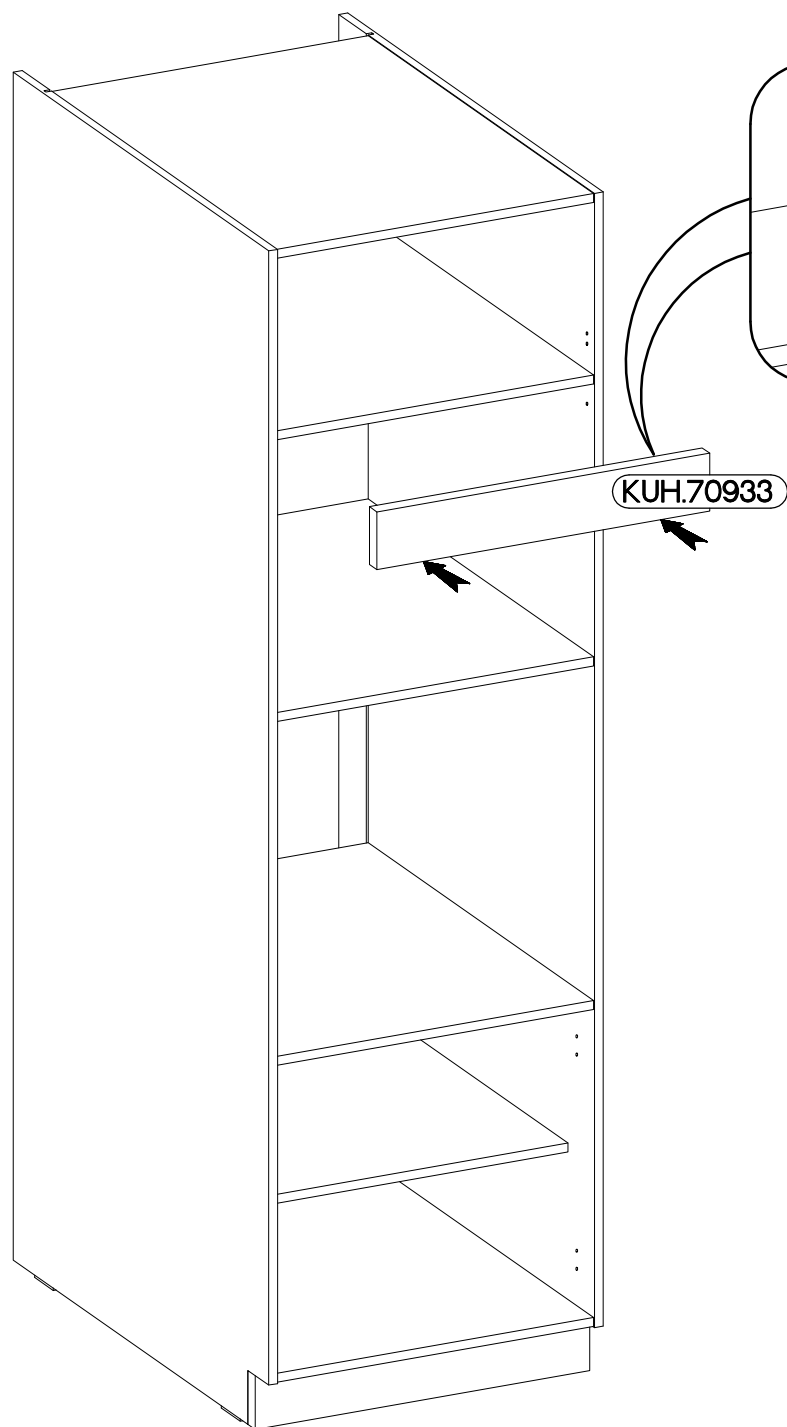
P1
2

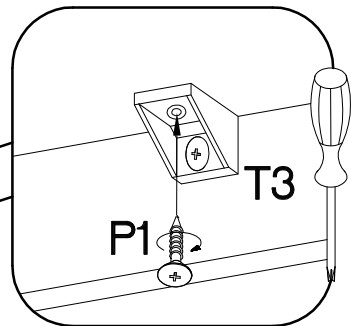

1.

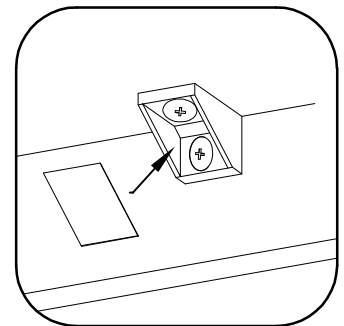

2.



5

M4x22mm U 4	L=128mm S 2	K24 2	J5 2
-------------------	-------------------	----------	---------

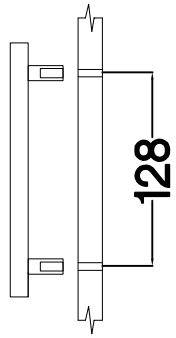
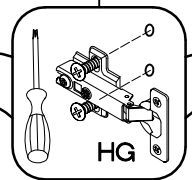
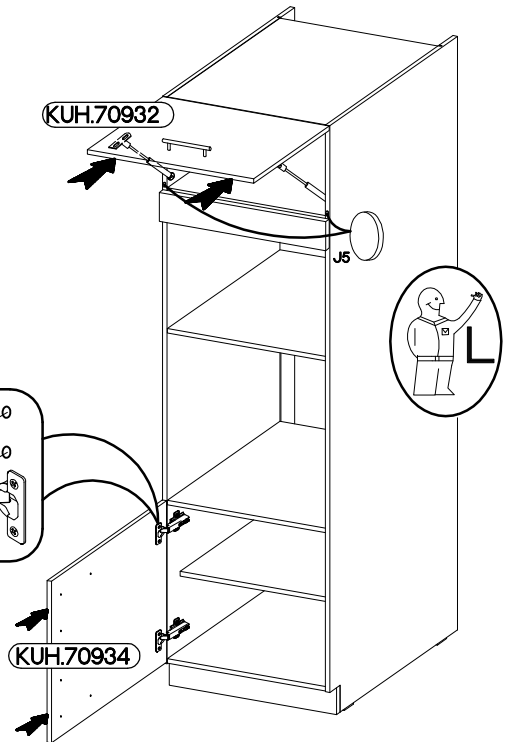
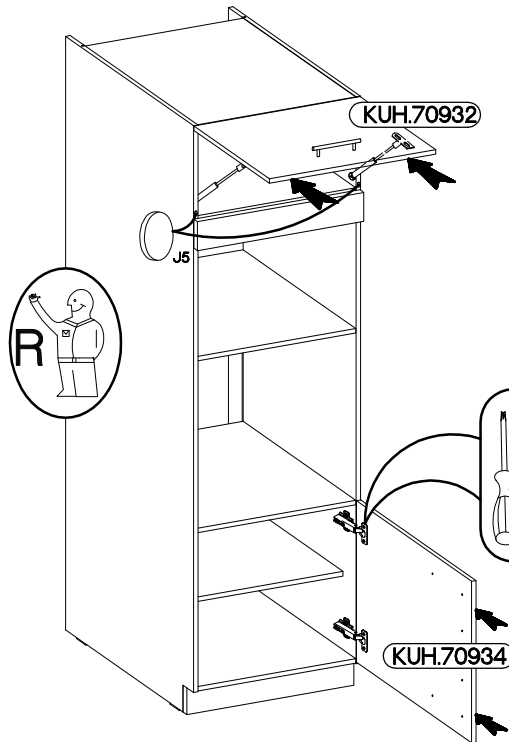
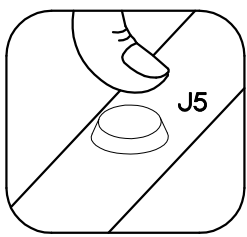
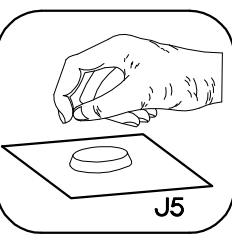
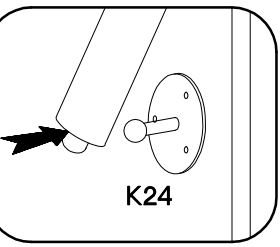
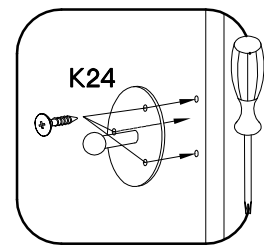
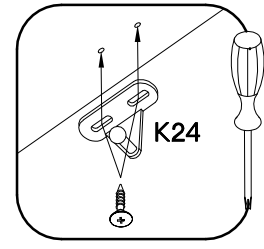
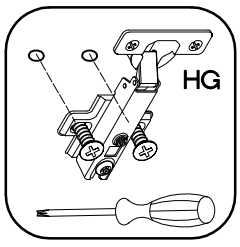
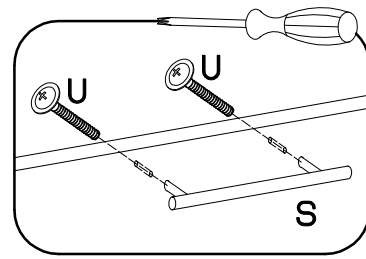

VARIANT HIGH GLOSS

