

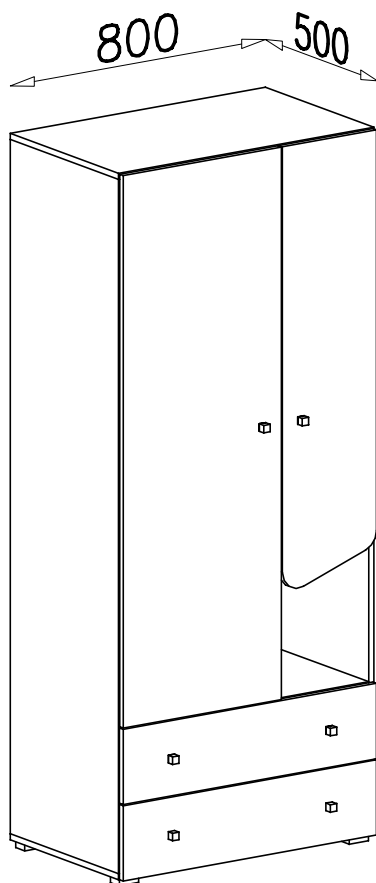

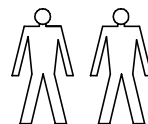

DELTA DL3

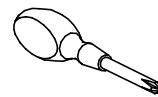
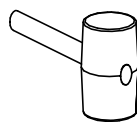
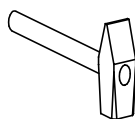
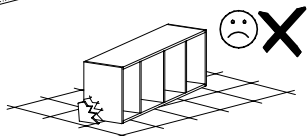
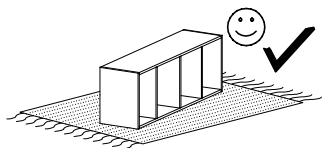
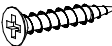

G12

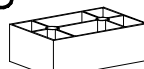
 3,5x25 x8

S1

 375mm x1

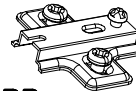
P15

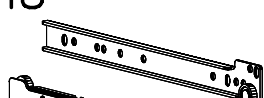
 x4

E38

 x6

D3

 PZ35PR x5

H8

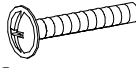
 400mm x2

S2

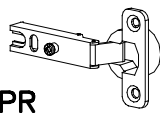
 x10

W1

 GLUE, LEIM, LEPIDLO, LIM
 x2

N13

 M4x22 x6

C3

 Z35PR x5

H8
 400mm x2

S5

 458mm x1

G4

 4x16 x22

G2

 3x20 x60

G6

 3x13 x2

G10

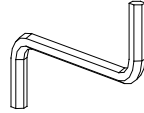
 6x13 x8

A1

 ø7x50 x16

B7

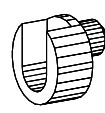
 ø8x30 x40

W2

 x1

F1

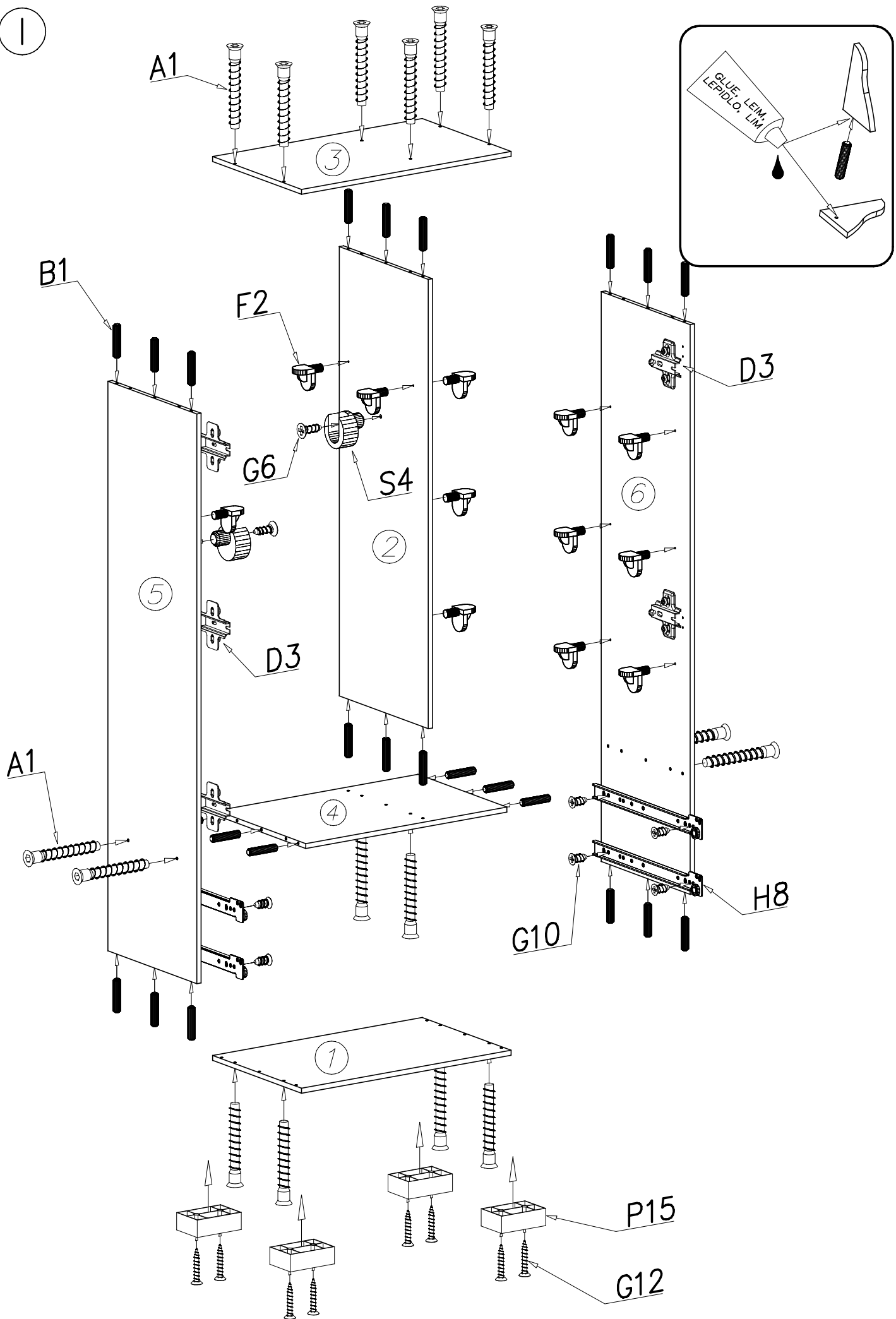
 x16

S4

 x2

I

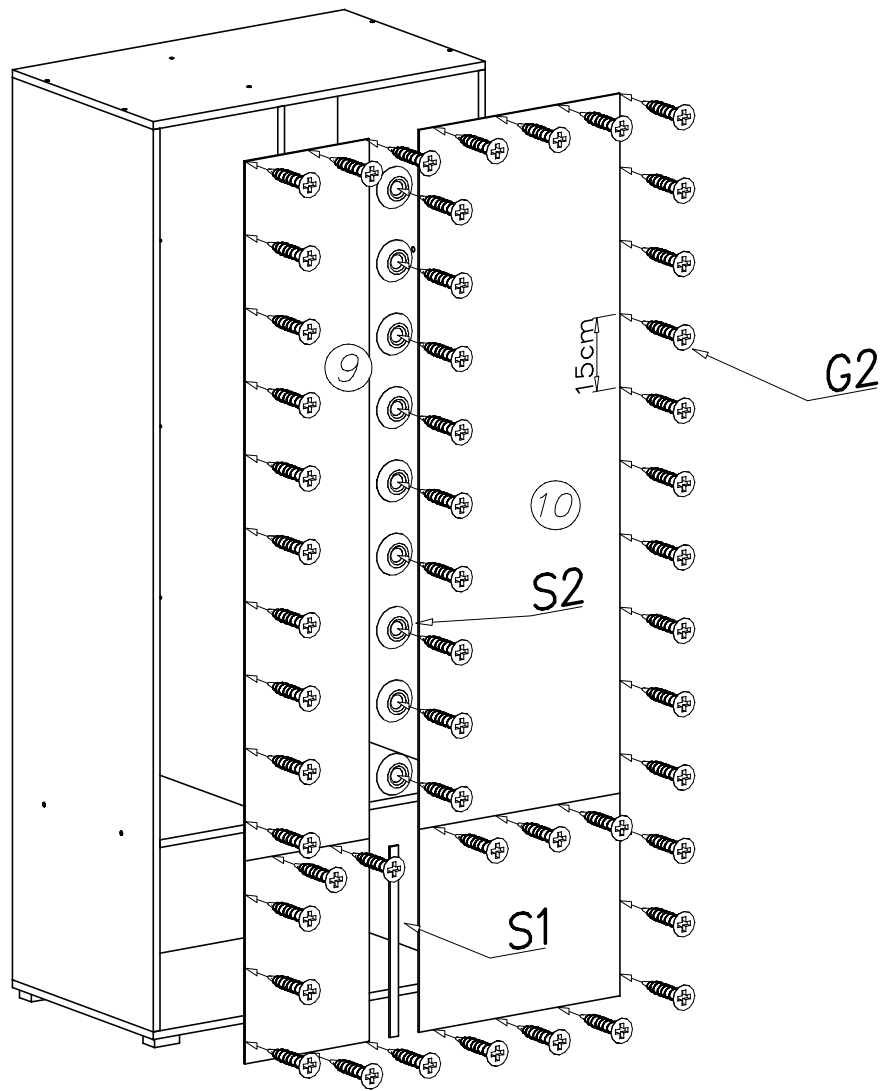

II



III

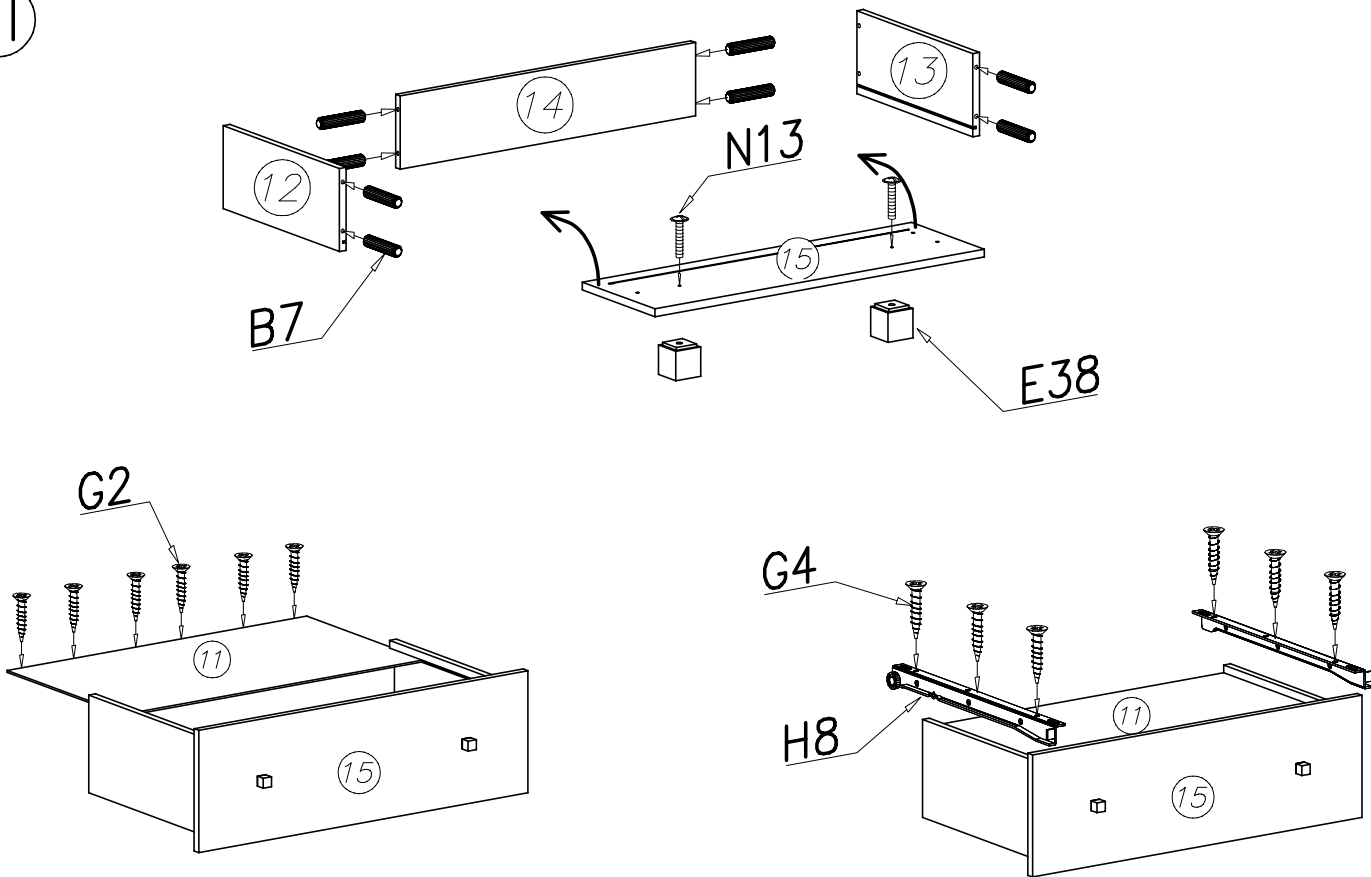

IV

