

**HSG 50/190**

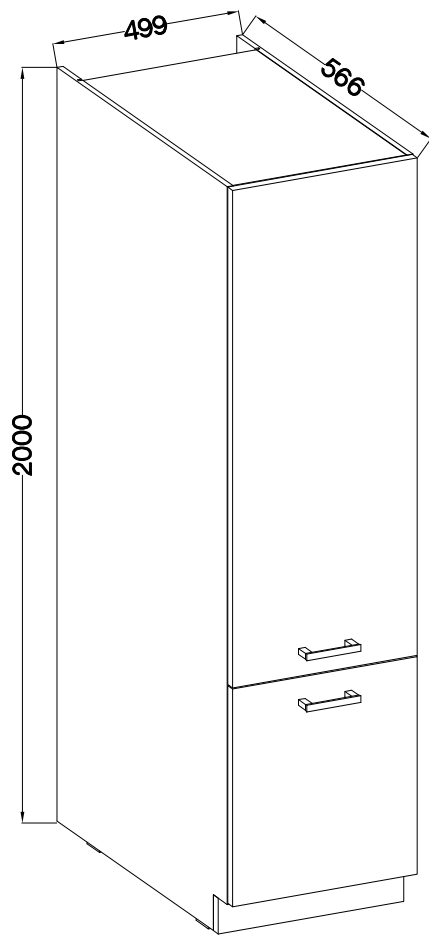
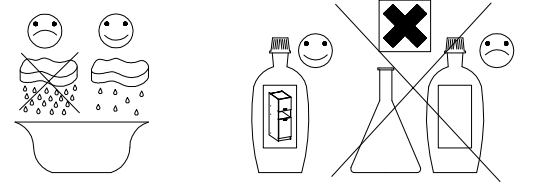

max. 5kg

KUH.30003  
KUH.40006  
KUH.40059

1h

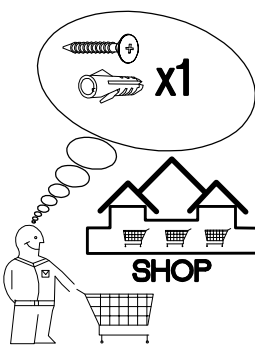
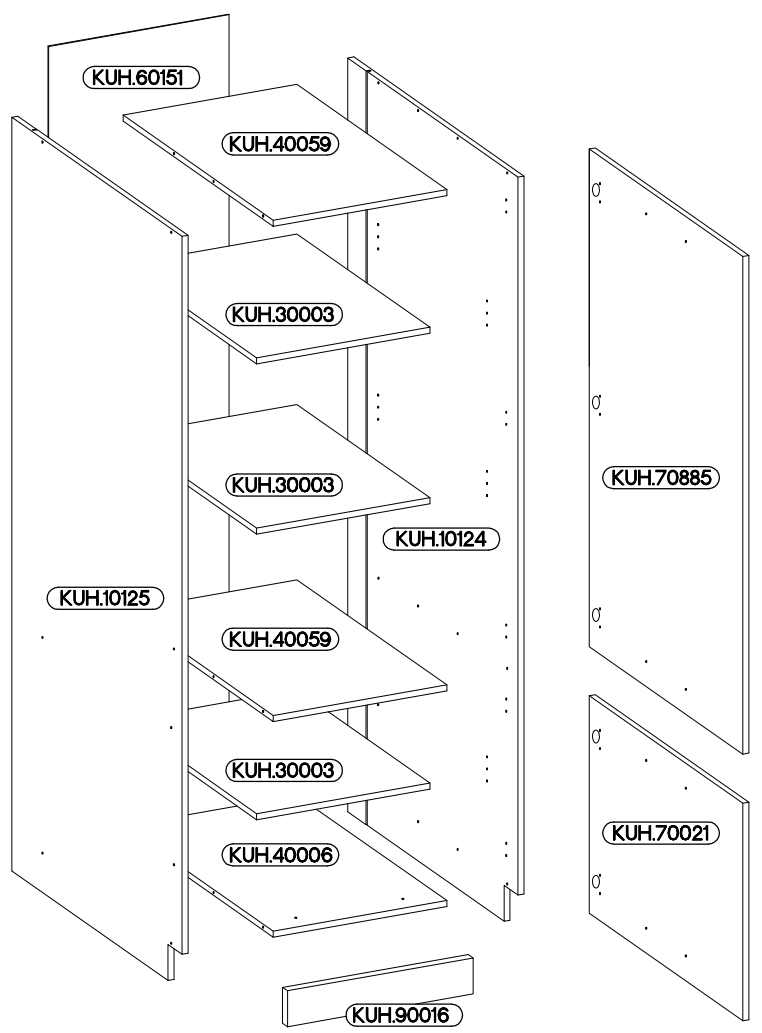

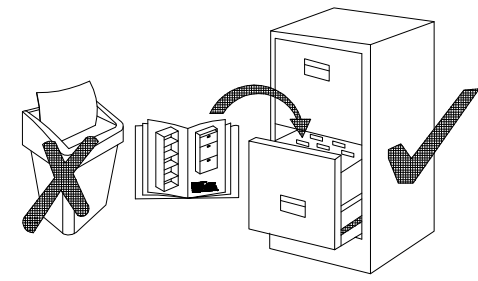

<p>†8x30mm</p> <p><b>A</b></p> <p>12</p>	<p>6,4 x 50mm</p> <p><b>B</b></p> <p>12</p>	<p><b>E1</b></p> <p>12</p>	<p><b>E9</b></p> <p>2</p>	<p>6.5x48x16</p> <p><b>F2</b></p> <p>4</p>	<p>†35/0mm</p> <p><b>HG</b></p> <p>5</p>	<p>†5/19mm</p> <p><b>J</b></p> <p>12</p>
<p>120x30x15mm</p> <p><b>L25</b></p> <p>1</p>	<p><b>O</b></p> <p>1</p>	<p>†4.0x45mm</p> <p><b>P4</b></p> <p>2</p>	<p>†3.5x13mm</p> <p><b>P5</b></p> <p>12</p>	<p>†3.0x20mm</p> <p><b>P7</b></p> <p>12-15</p>	<p>†4.0x30mm</p> <p><b>R2</b></p> <p>4</p>	<p>L=128mm</p> <p><b>S</b></p> <p>2</p>

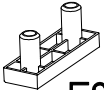

**ISM-KUH-01528**

1

6.5x48x16	±8x30mm
 F2	 A
4	12

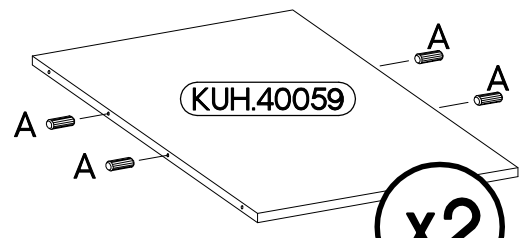
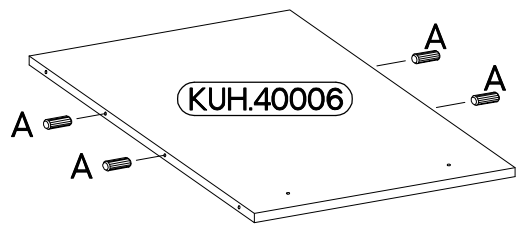
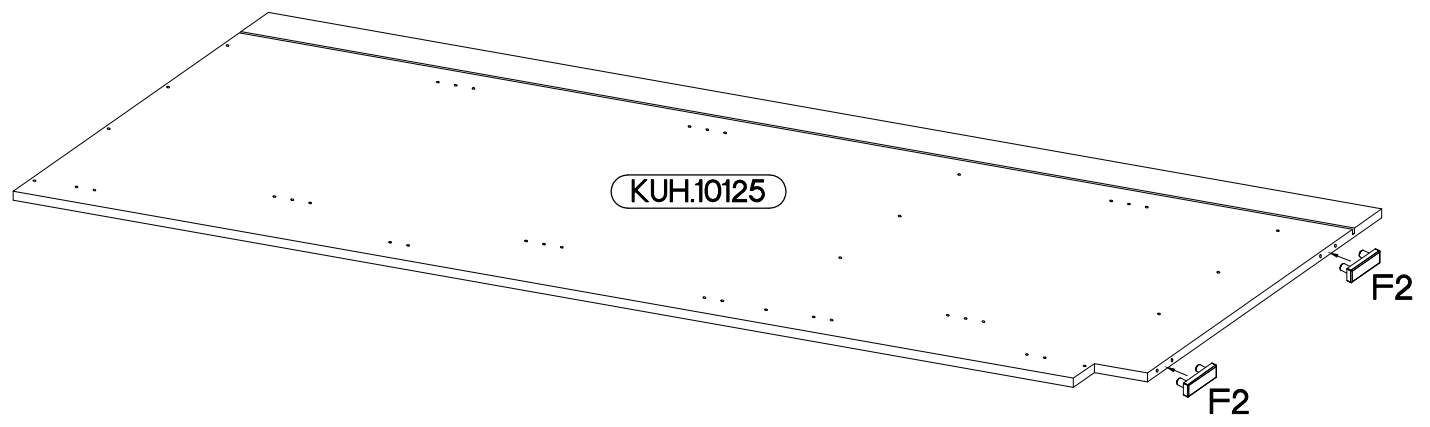
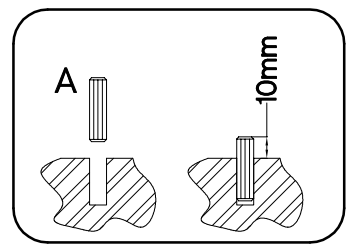
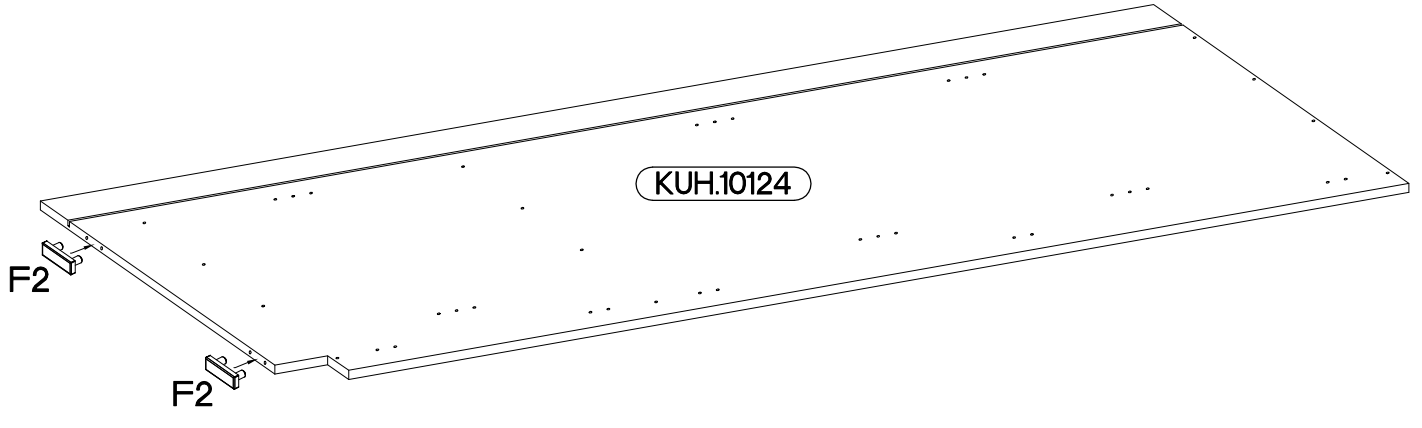
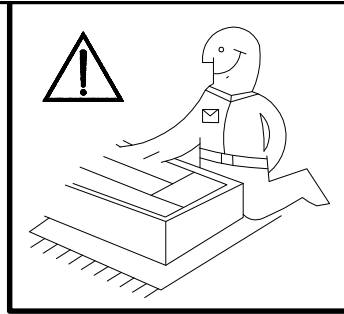
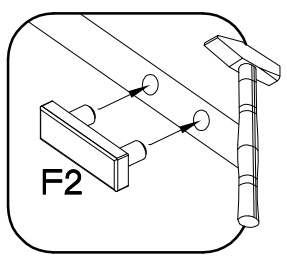

x2

2

6,4 x 50mm

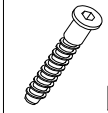

B

6

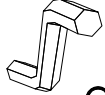

O

1

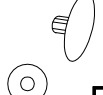

E1

6

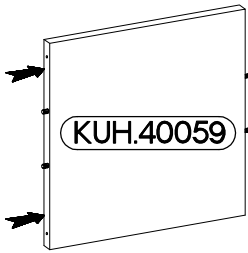

KUH.40059

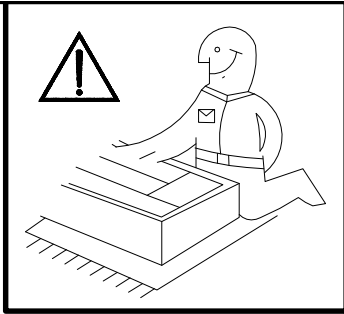
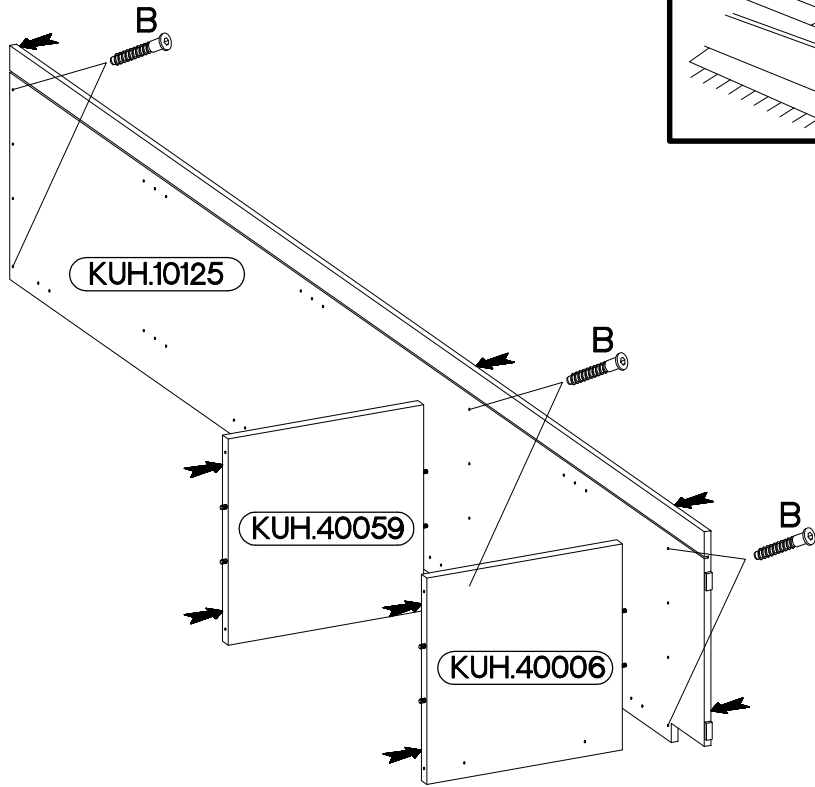

3

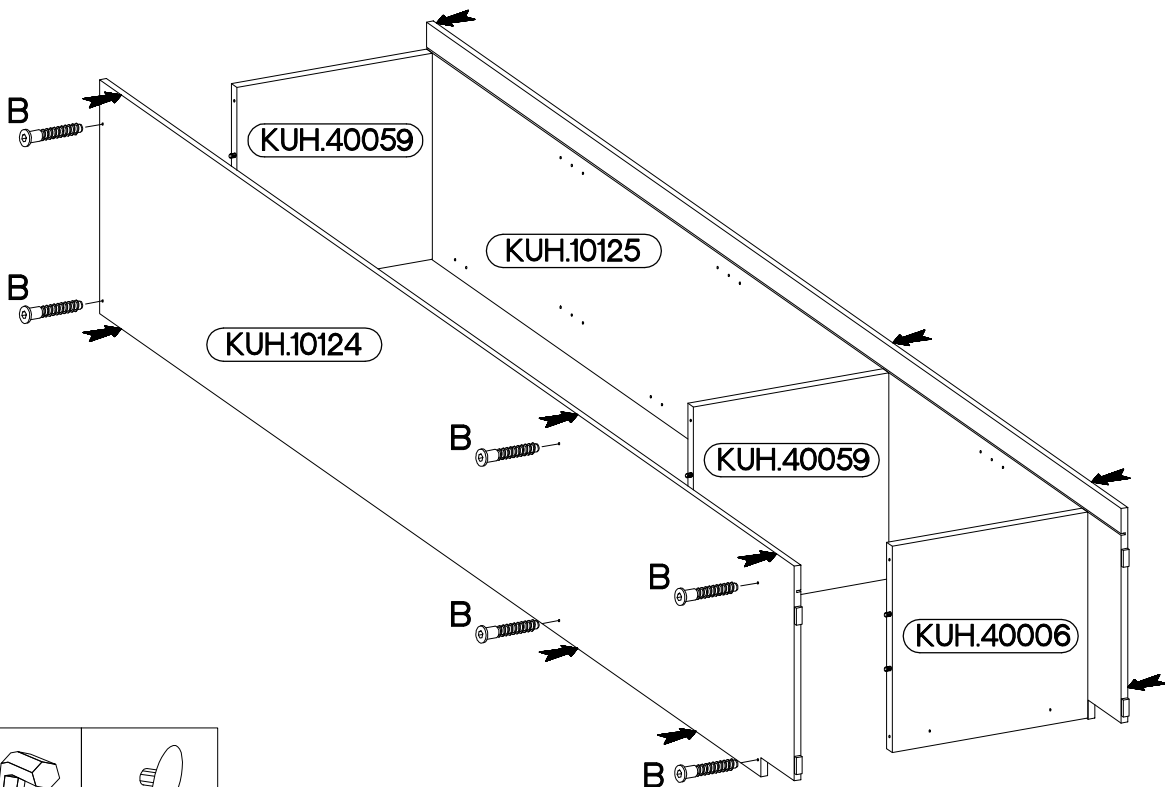
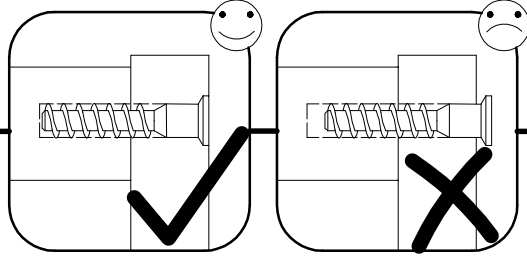
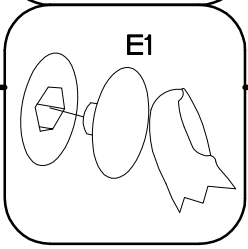
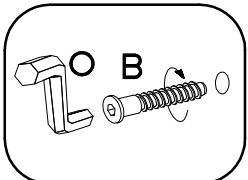

6,4 x 50mm

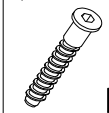

B

6



O

1

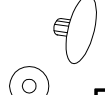

E1

6

4

±3.0x20mm



P7

12-15

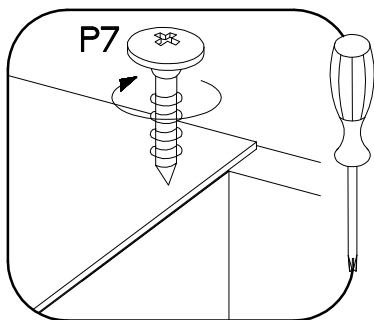
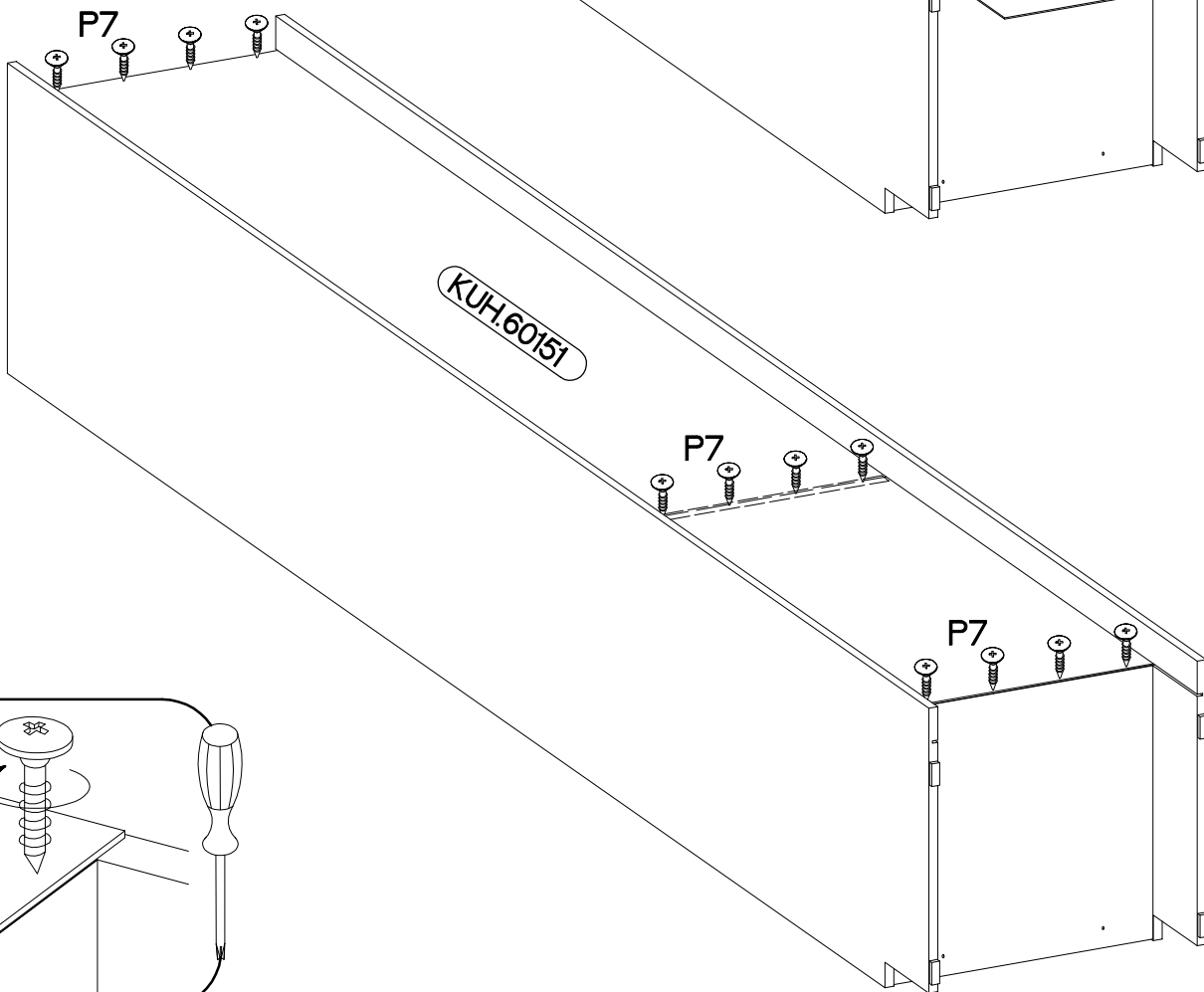
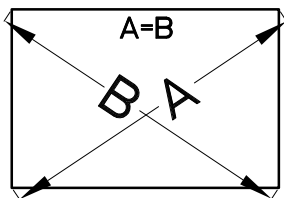
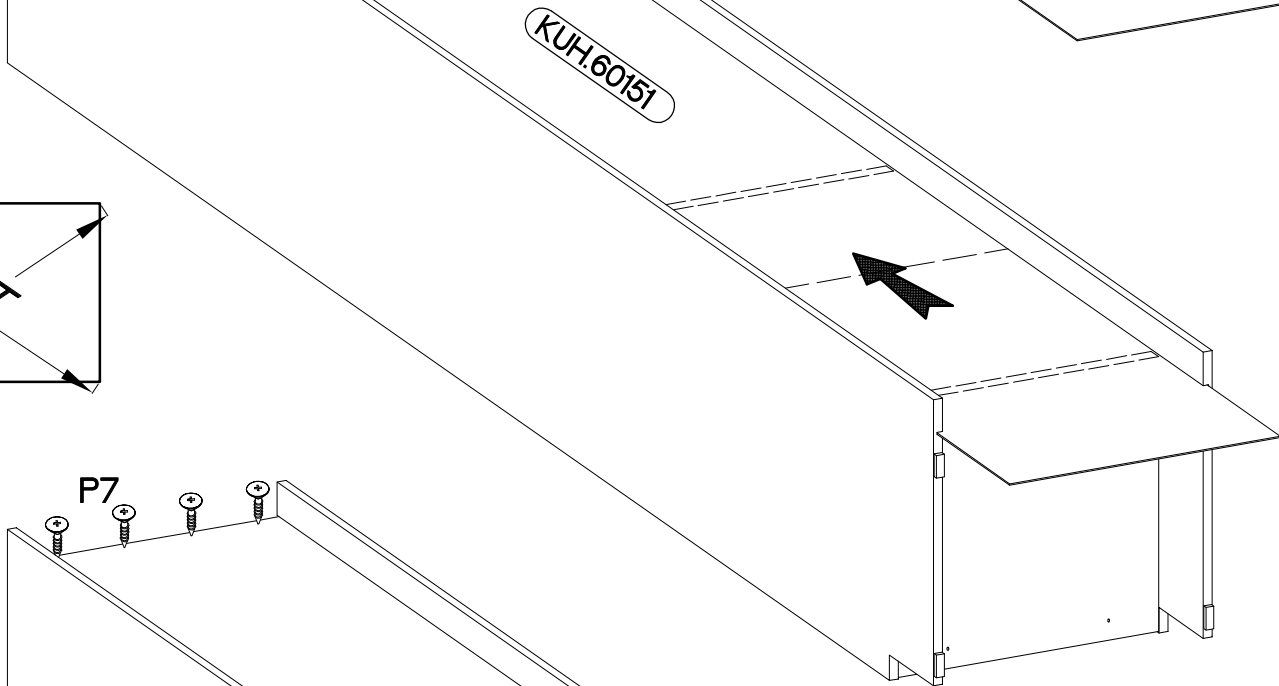
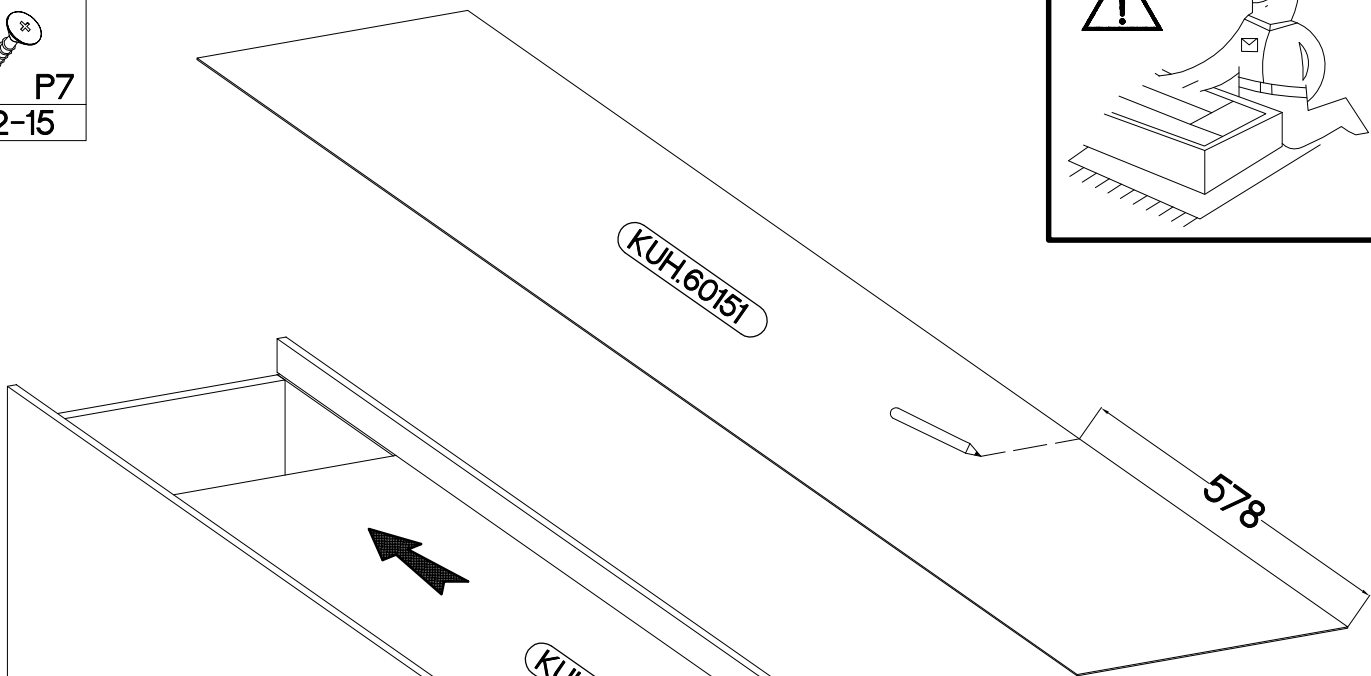
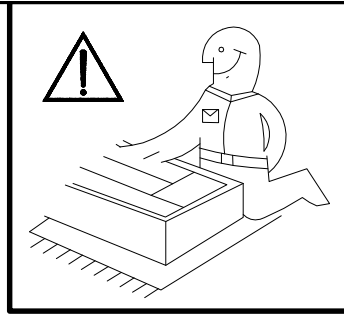

5

±4.0x45mm



P4

2



E9

2

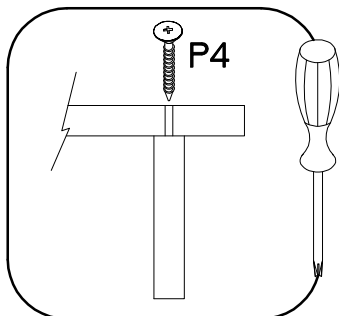
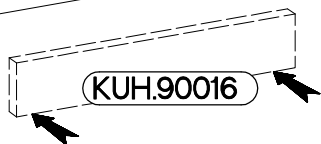
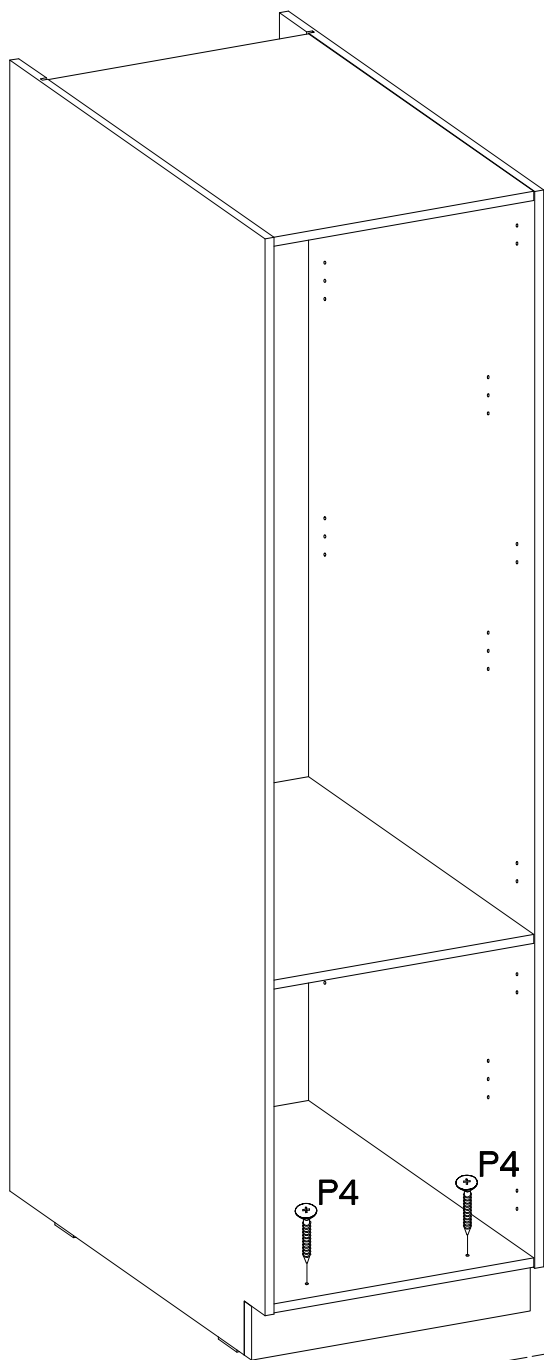

6

±5/19mm





J

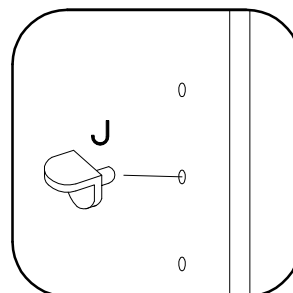
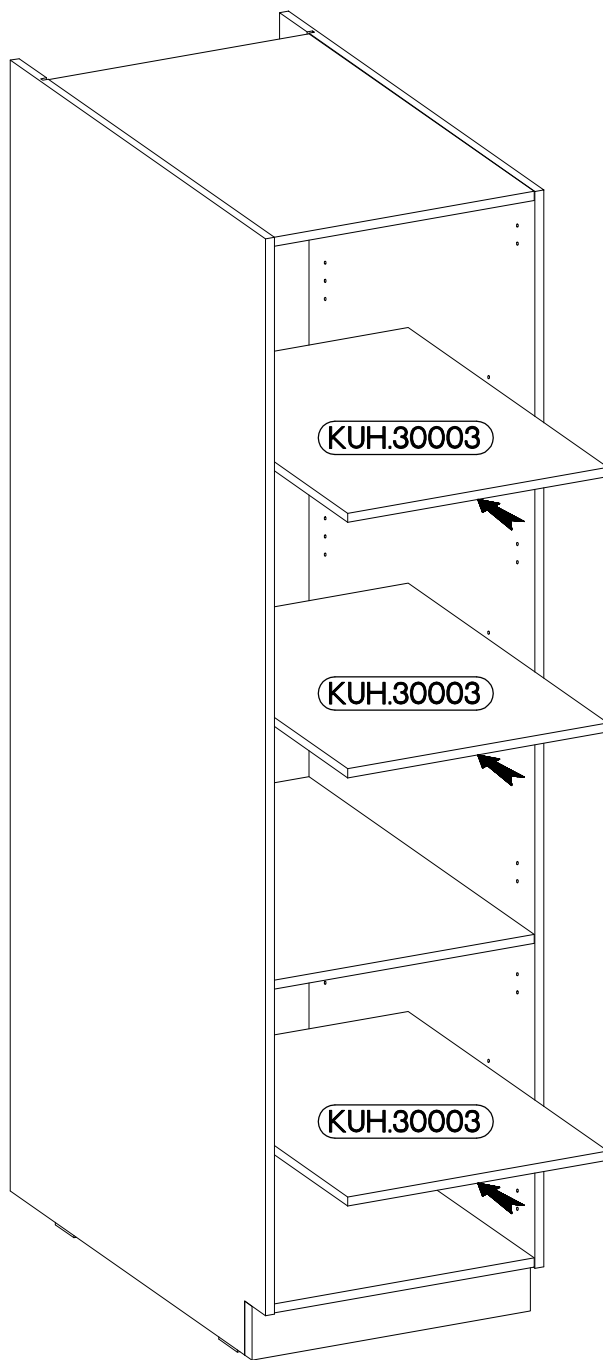

12

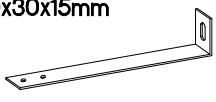

7

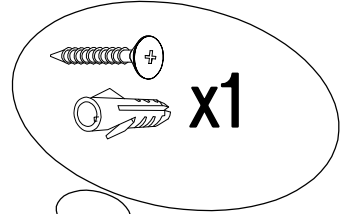
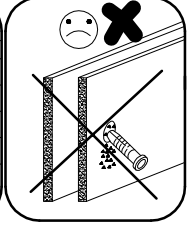
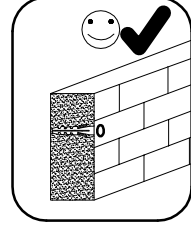
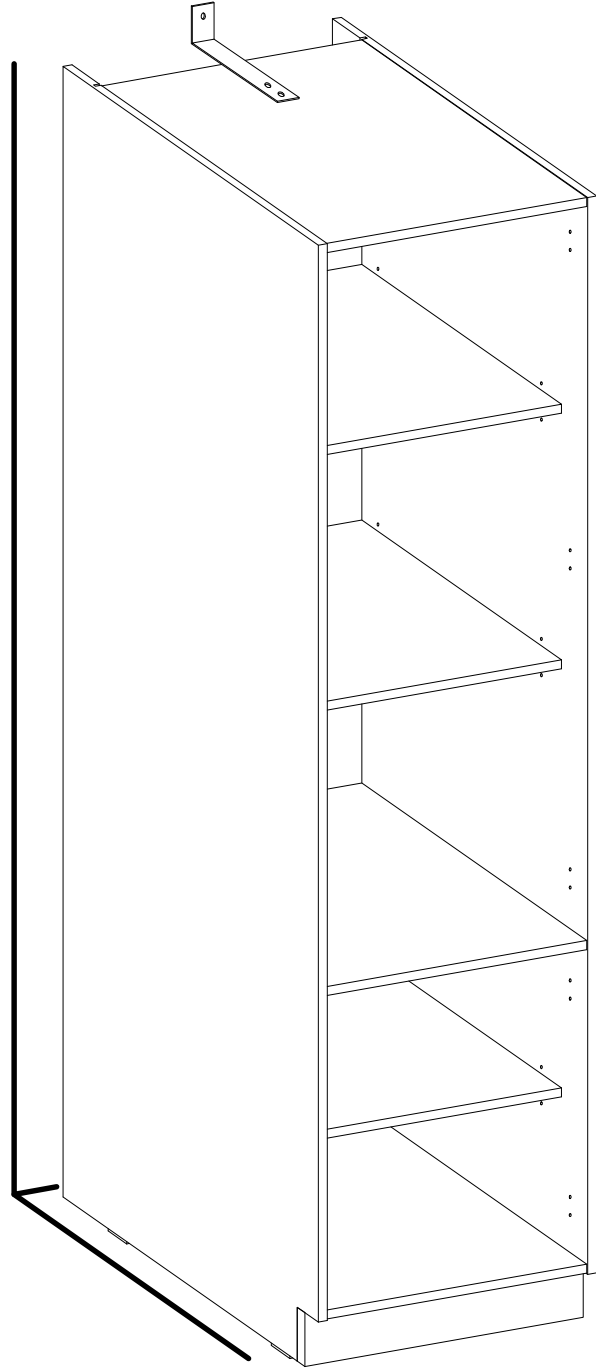
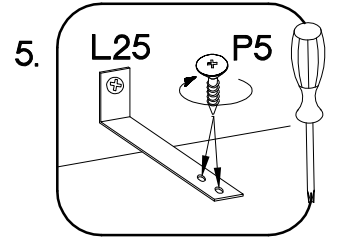
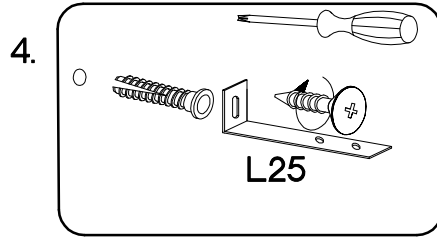
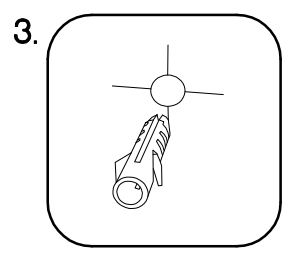
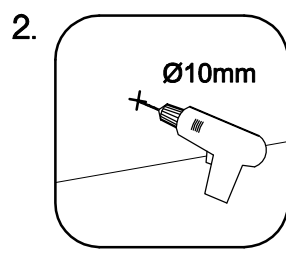
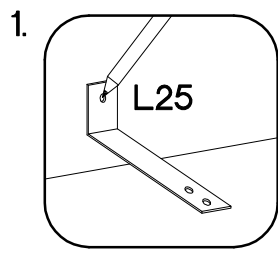
120x30x15mm  L25 1	±3.5x13mm  P5 2
---	--



∅35/0mm  HG 5	∅3.5x13mm  P5 10
--	---

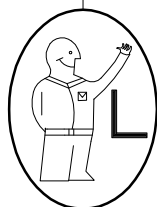
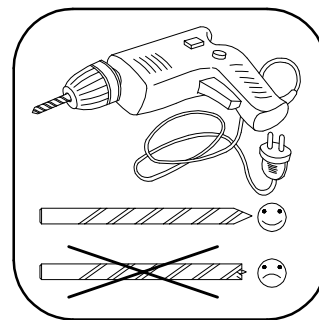

KUH.70885

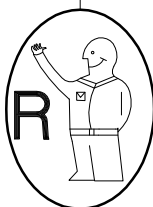

KUH.70885

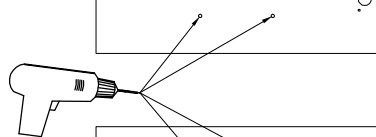
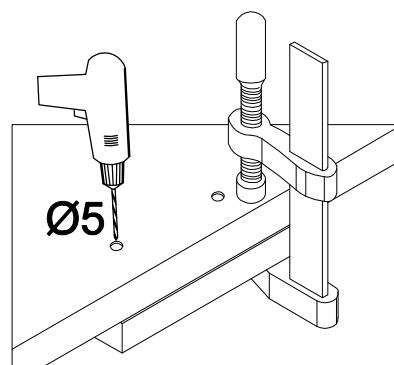

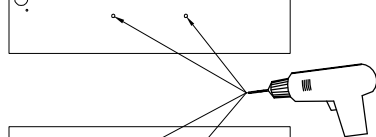

KUH.70021

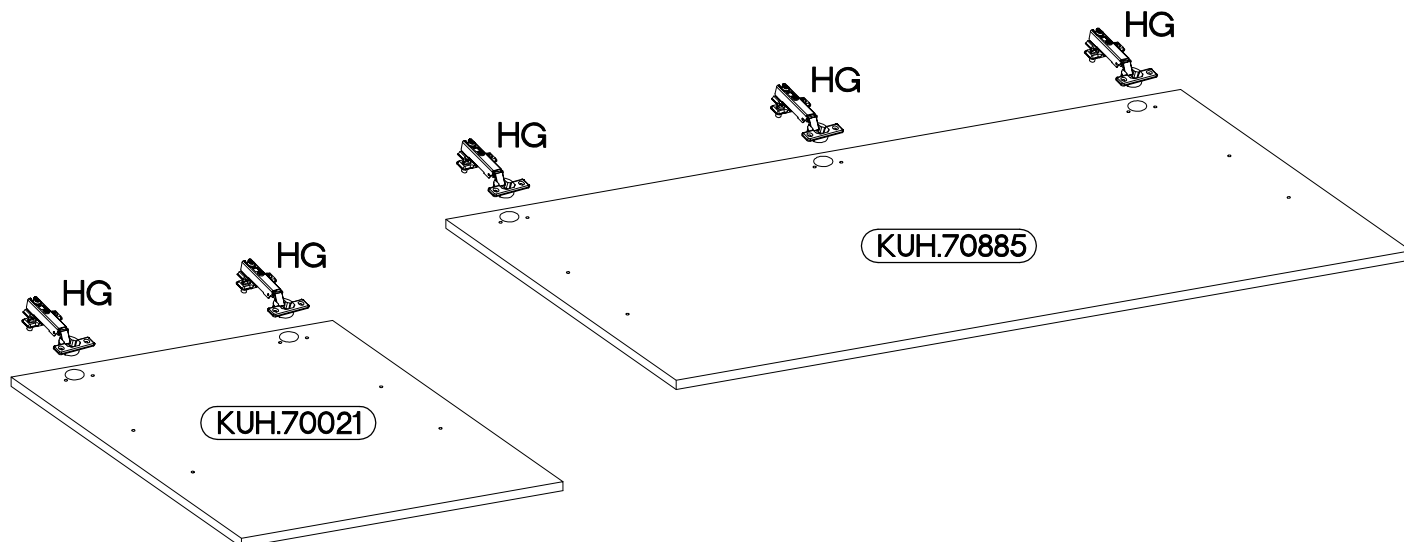
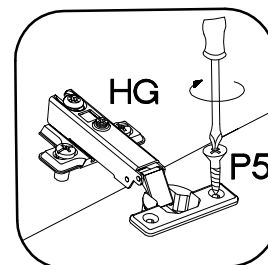

KUH.70021

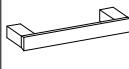

L=128mm	+4.0x30mm
	
S	R2
2	4

