

NATURAL 8



Narzędzia potrzebne do montażu



UWAGA !!!

MONTOWANIE USZKODZONYCH
ELEMENTÓW POWODUJE UTRATĘ
GWARANCJI

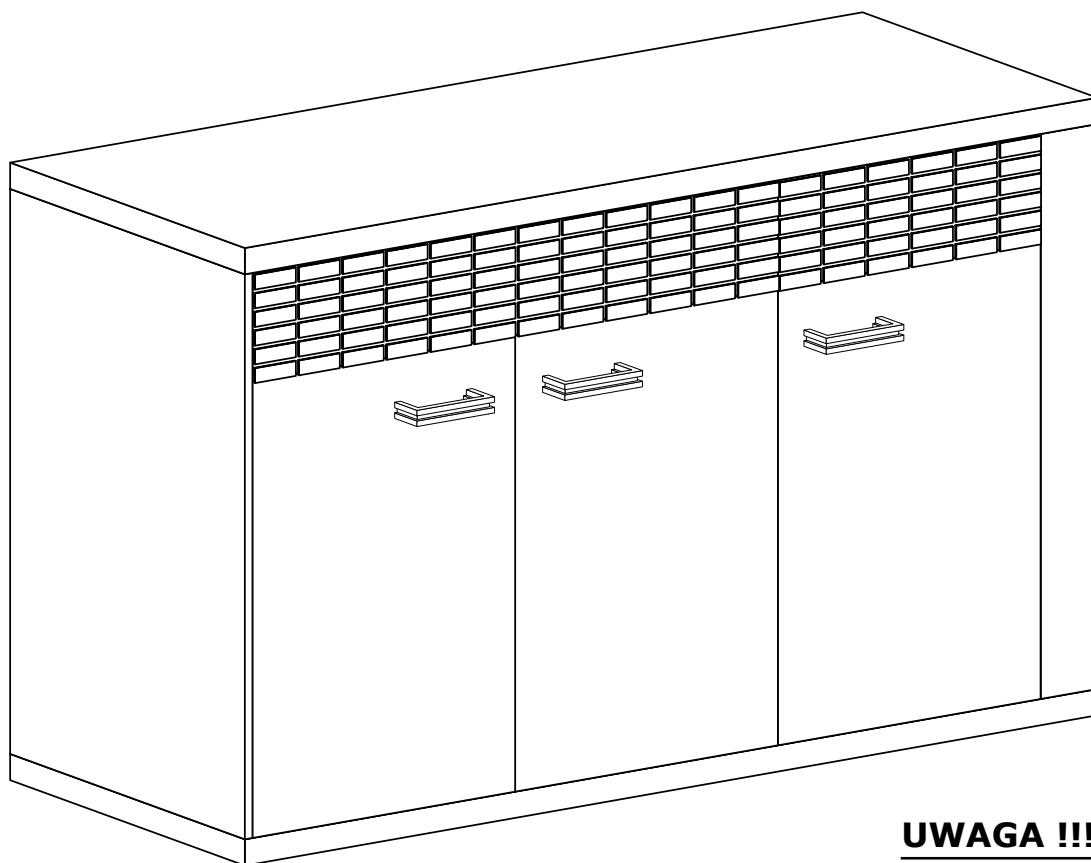

Nr	D[mm]	S[mm]	G[mm]	Ilość
1	885	405	16	1
2	885	389	16	1
3	1462	406	48	1
4	1462	406	48	1
5	1430	389	16	1
6	673	389	16	1
7	368	197	16	1
8	389	197	16	1
9	890	389	16	1
10	522	389	16	1
11	885	100	16	1
12	1455	345	2,5	2
13	1455	247	2,5	1
14	350	165	16	4
15	831	165	16	1
16	384	165	16	1
17	892	190	32	1
18	445	190	32	1
19	858	345	2,5	1
20	412	345	2,5	1
21	685	445	16	2
22	685	445	16	1



X1 - 21 St.

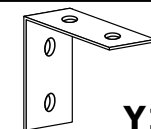

Y1 - 1 St.

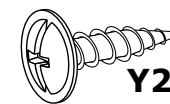

Y2 - 2 St.
3,5x16 mm

W przypadku reklamacji proszę podać numer pakowacza znajdujący się na kartonie.



A - 3 St.

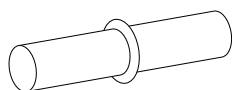

B - 8 St.

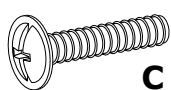

C - 6 St.
4x22 mm

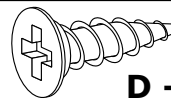

D - 30 St.
3,5x16 mm

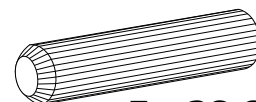

E - 28 St.

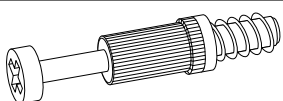

F - 25 St.

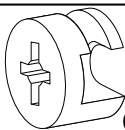

G - 25 St.

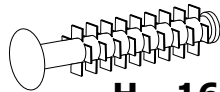

H - 16 St.

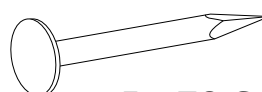

I - 70 St.

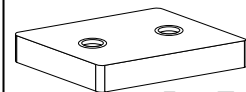

J - 5 St.

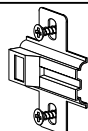

L - 6 St.

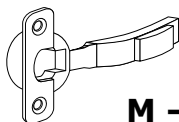

M - 2 St.

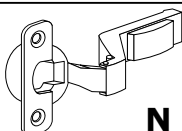

N - 2 St.

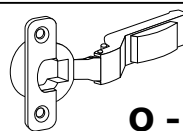

O - 2 St.

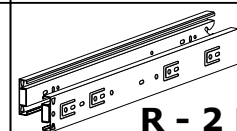

R - 2 Kpl.



S - 10 St.
3,5x25 mm

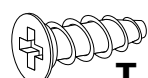

T - 16 St.
5x13 mm

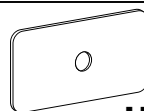

U - 18 St.



W - 48 St.
3x30 mm

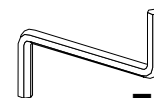

Z - 1 St.

UWAGA !!!

Mebel zawiera
elementy drewniane

I

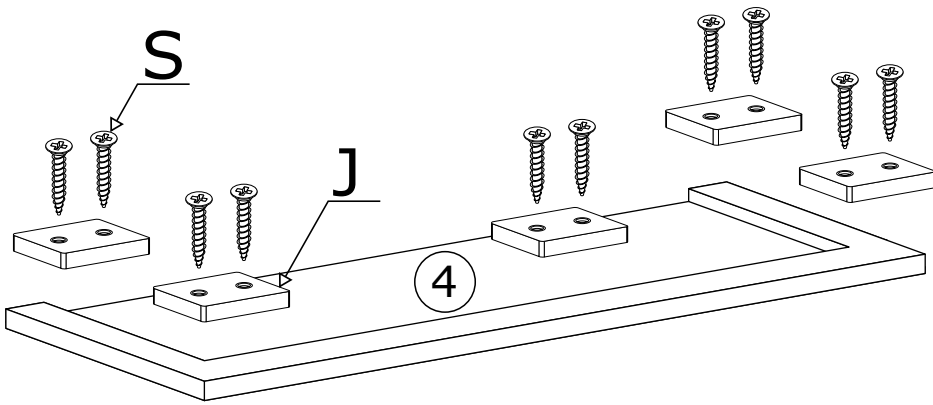

II

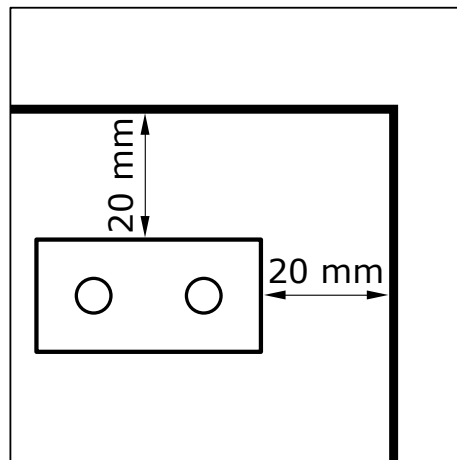
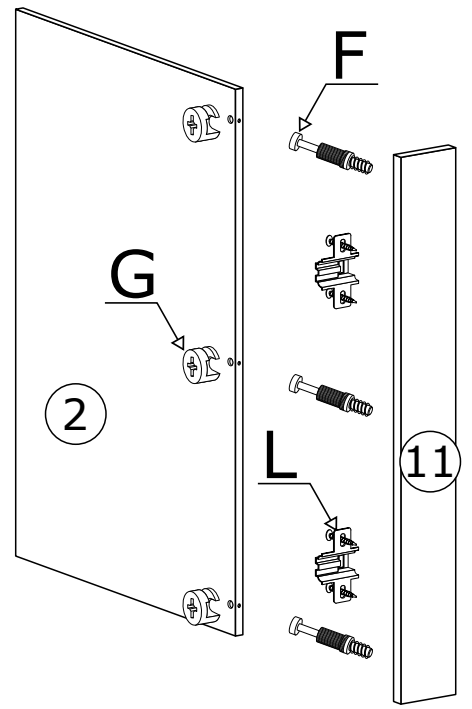

III

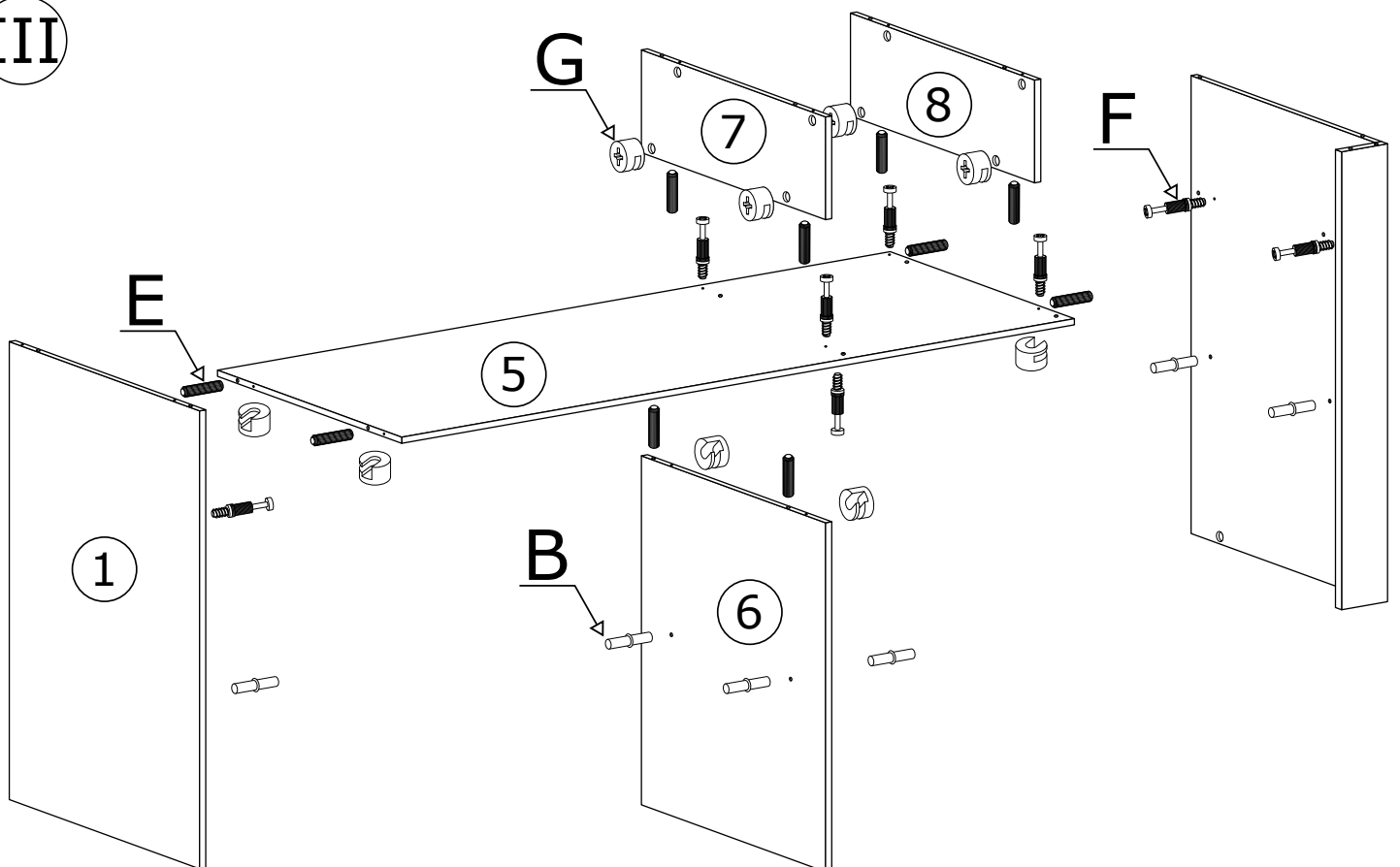

IV

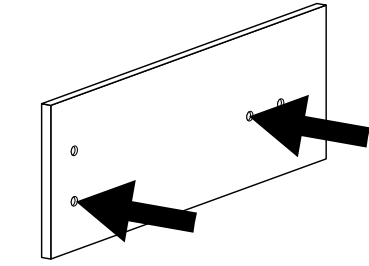
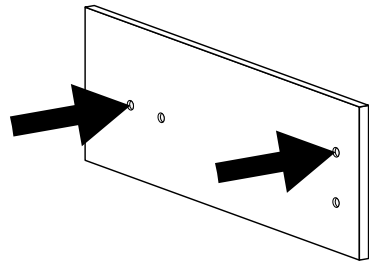

30mm

Opcja LED

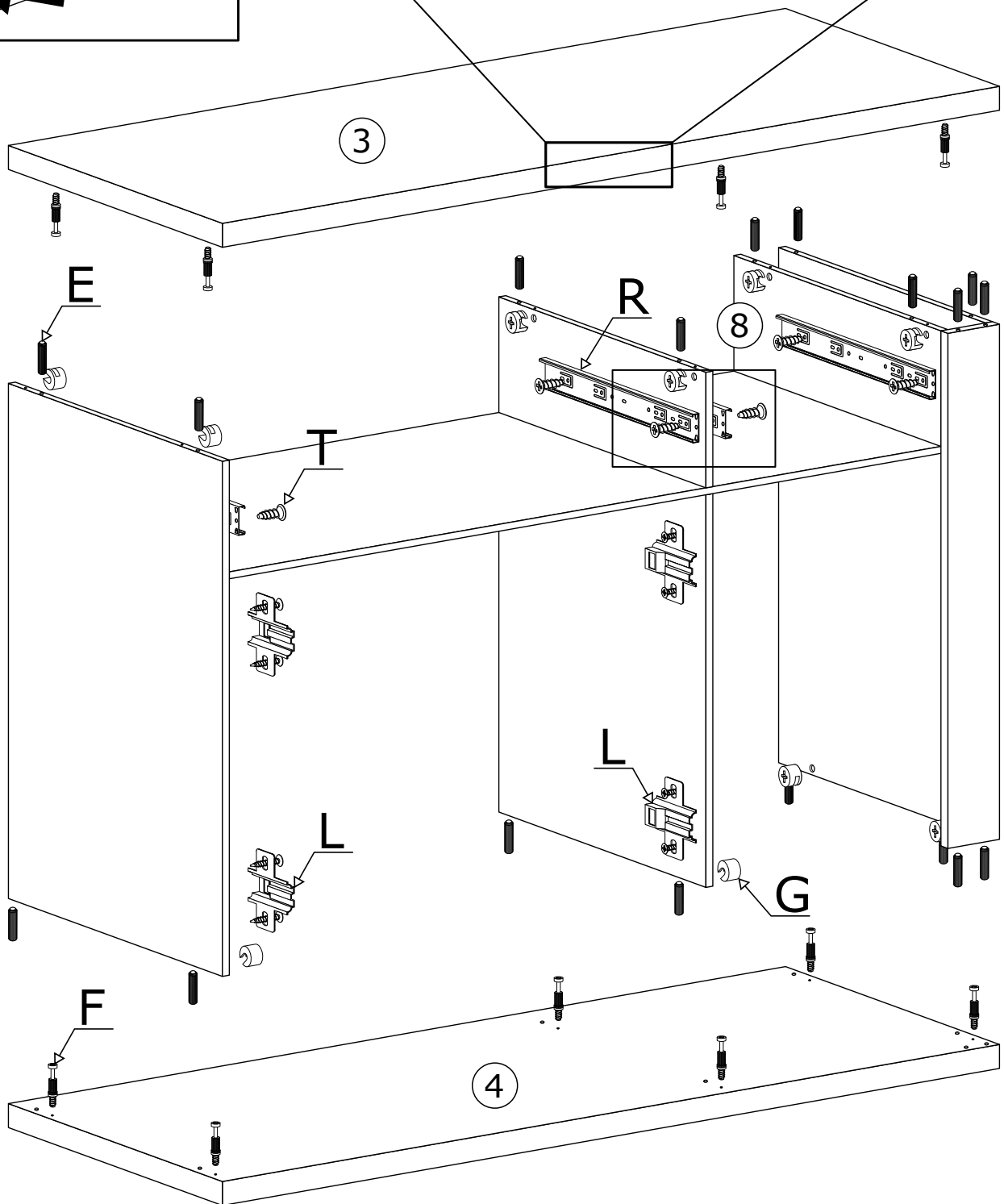

V

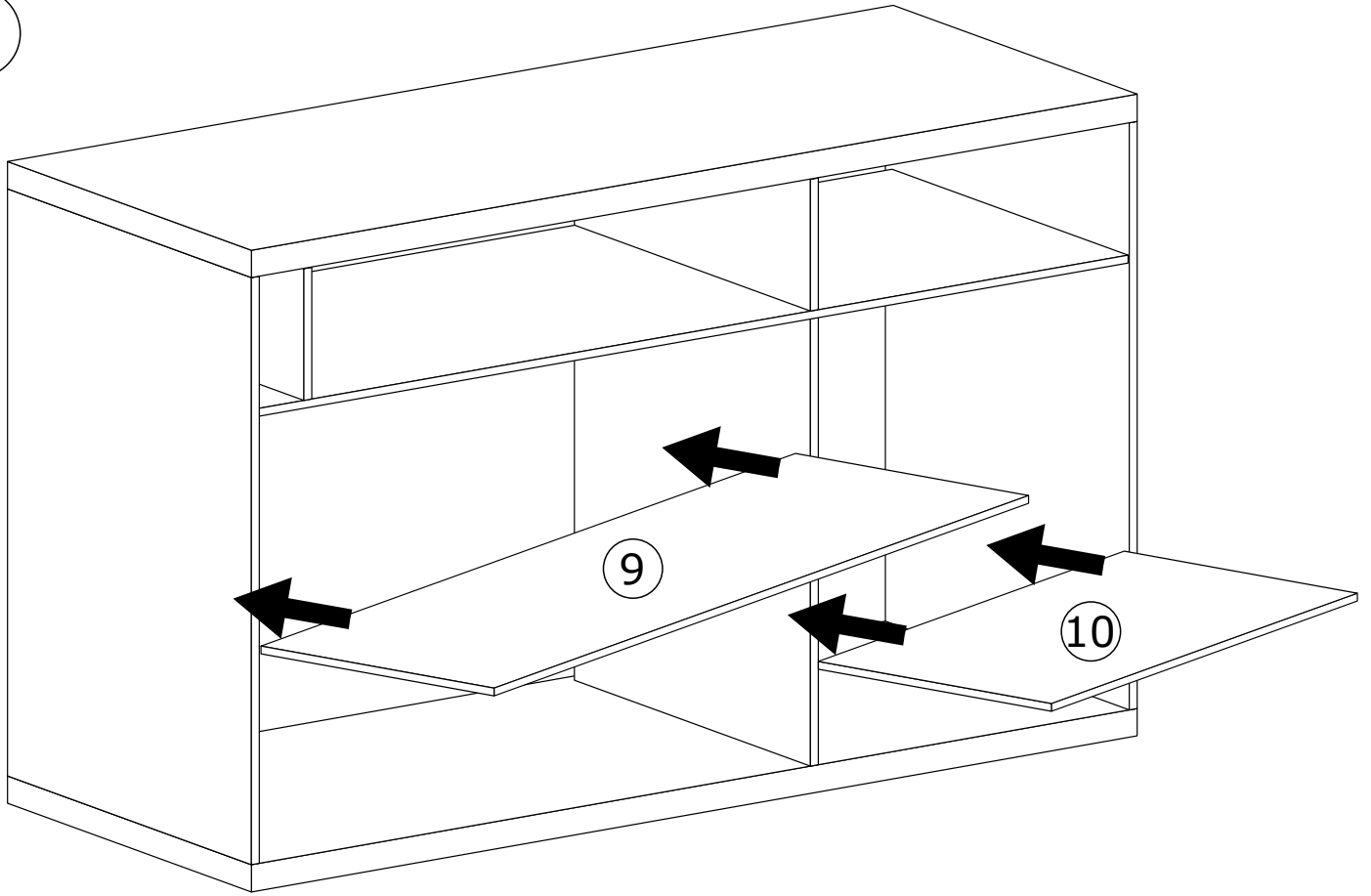

VI

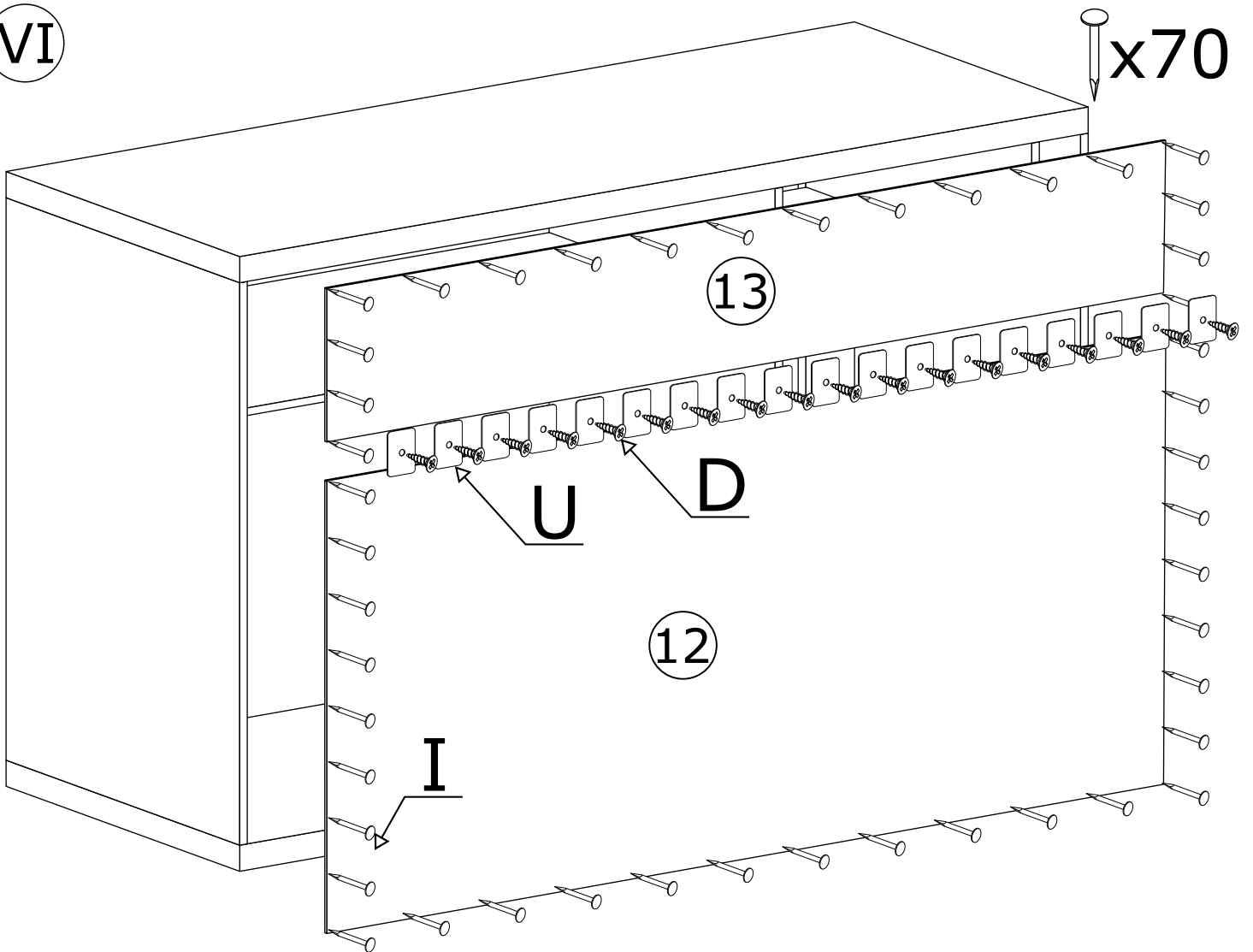

VII

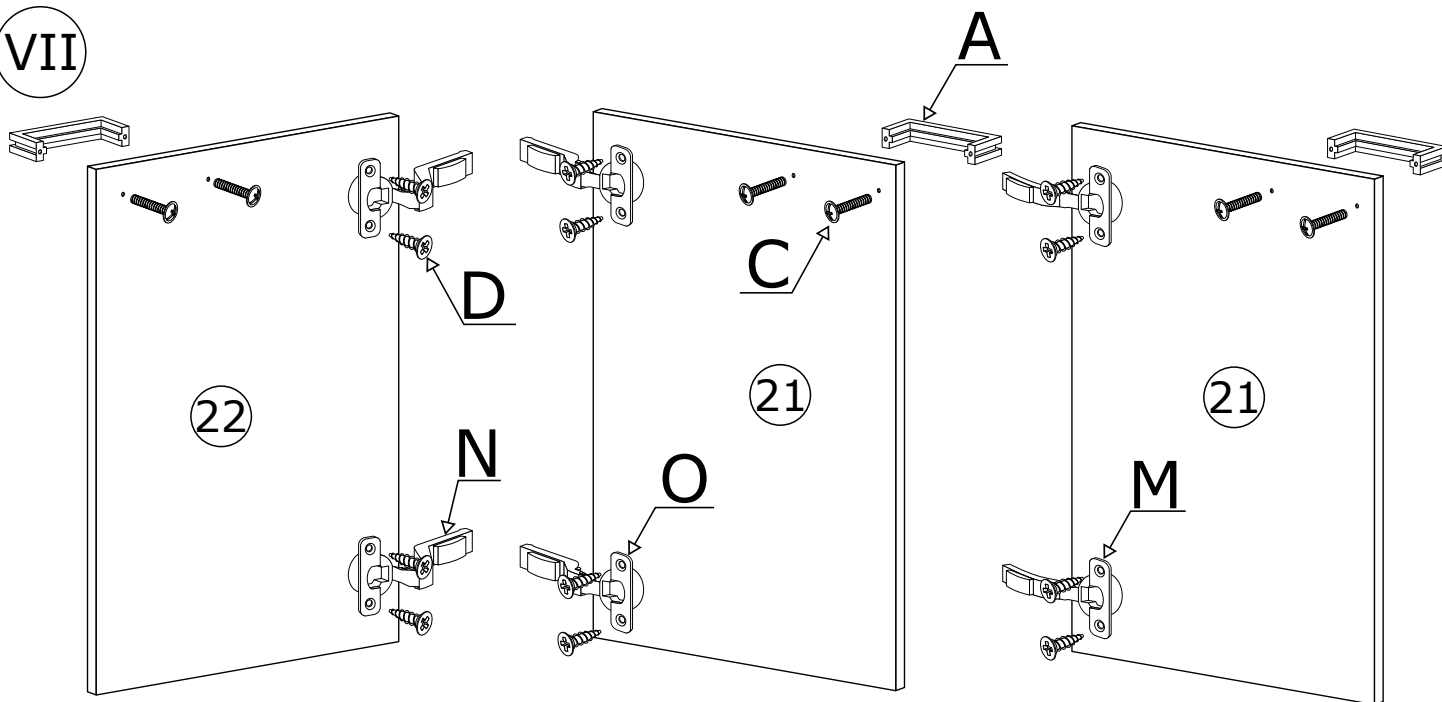

VIII

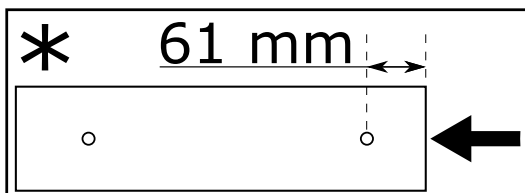
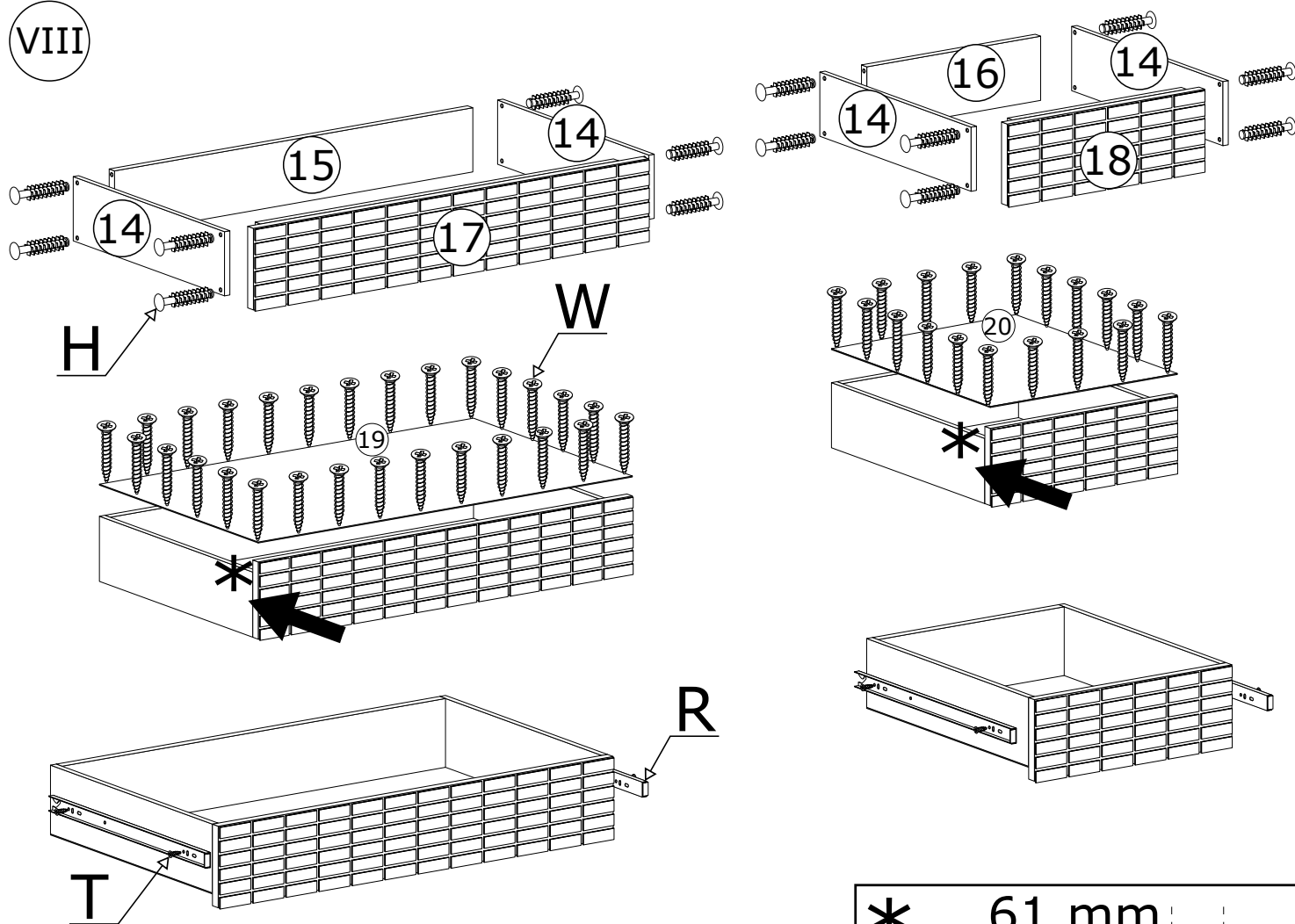

ELEMENT OZDOBNY WYKONANY RĘCZNIE Z PRAWDZIWEGODREWNA. ODCIEŃ DREWNA I OKŁAD SŁOI MOGĄ NIEZNACZNIE ODBIEGAĆ OD PREZENTOWANYCH NA ZDJĘCIACH KATALOGOWYCH.

IX

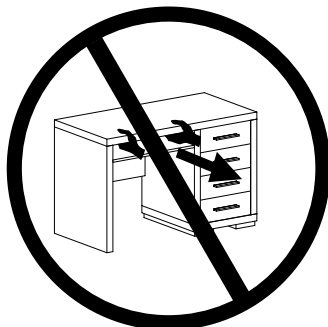
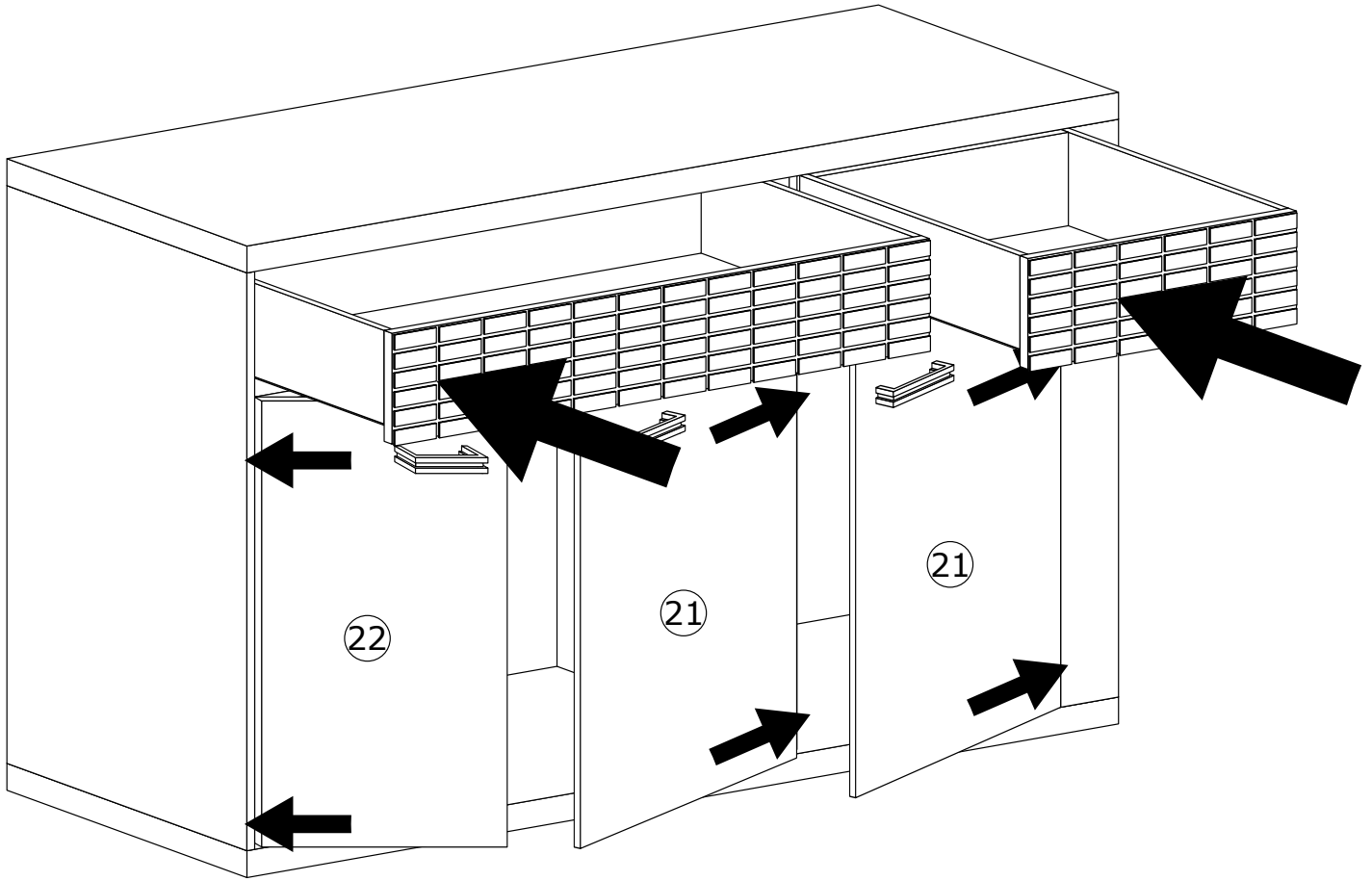

MONTAŻ/DEMONTAŻ PROWADNIC

1

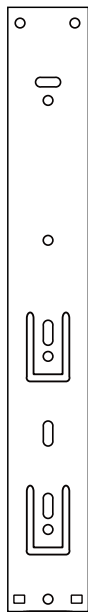

2

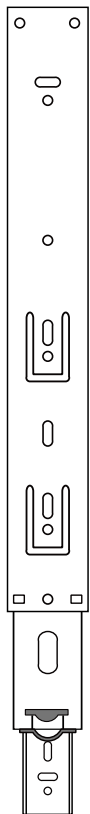

3

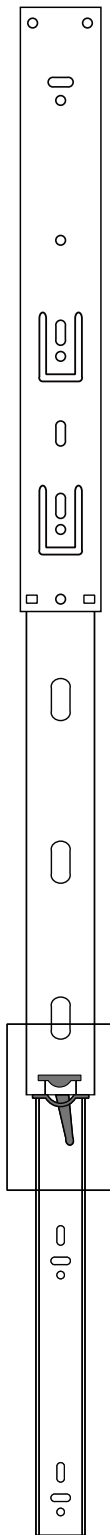

4

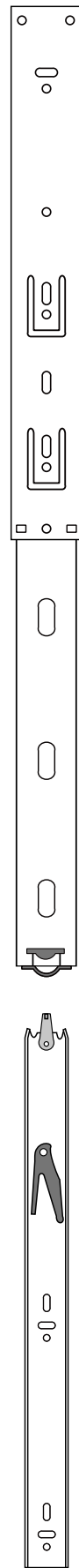

MONTAŻ KĄTOWNIKA

