

TADEUSZ 15

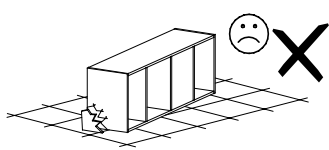

Narzędzia potrzebne do montażu

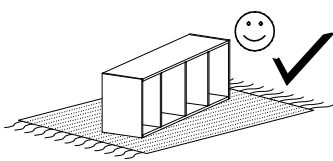
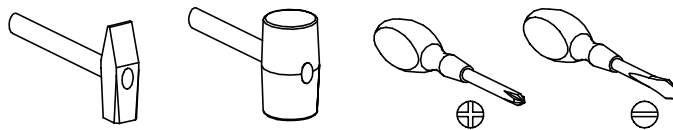

UWAGA !!!

MONTOWANIE USZKODZONYCH
ELEMENTÓW POWODUJE UTRATĘ
GWARANCJI

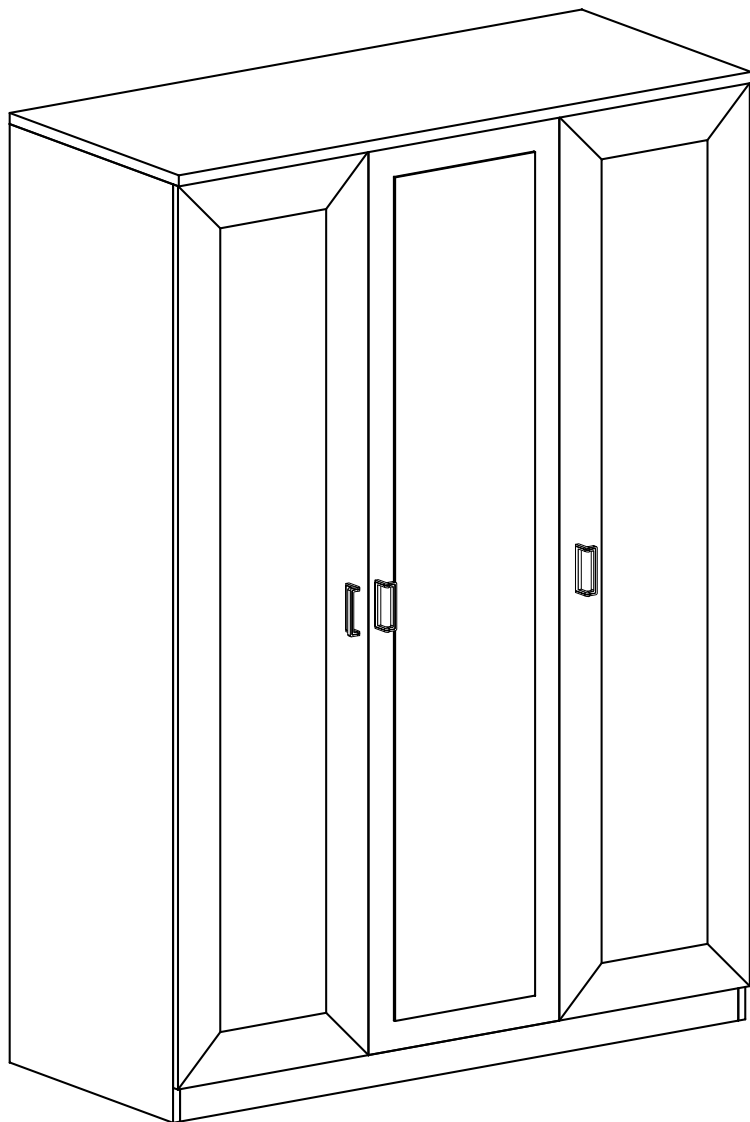

Nr	D[mm]	S[mm]	G[mm]	Ilość
1	1345	570	32	1
2	1298	540	16	1
3	1775	540	16	1
4	1298	80	16	2
5	510	423	16	4
6	1870	540	16	1
7	1870	540	16	1
8	1800	440	2,5	1
9	1800	880	2,5	1
10	858	510	16	1
11	1780	438	16	1
12	1780	438	16	1
13	1780	438	16	1

W przypadku reklamacji proszę podać numer pakowacza znajdujący się na kartonie.

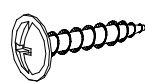

I - 4 St.
3,5x16 mm

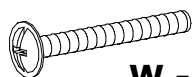

W - 4 St.
4x37 mm



Y - 10 St.

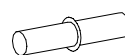

P - 20 St.

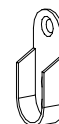

Y - 2 St.

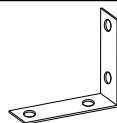

O - 2 St.

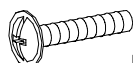

N - 2 St.
4x25 mm



U - 3 St.



G - 32 St.
3,5x16 mm



L - 10 St.

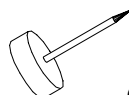

Q - 6 St.



E - 60 St.

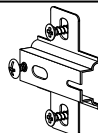

C - 9 St.

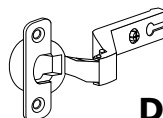

D - 9 St.



S - 1 St.

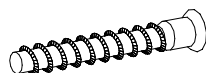

R - 6 St.



B - 20 St.

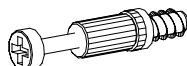

K - 10 St.

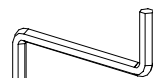

Z - 1 St.



R - 1 St.

I

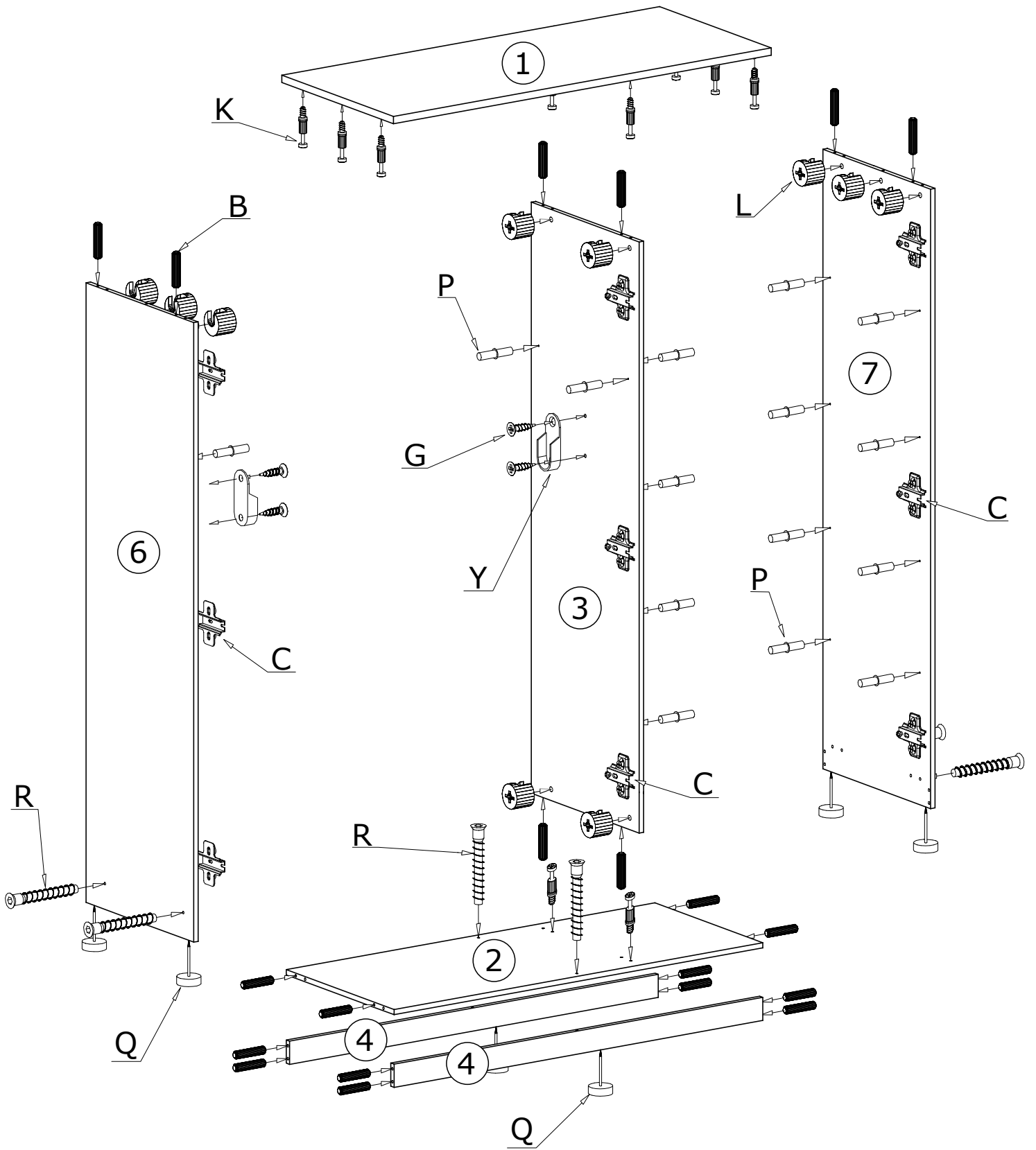

II

60X 

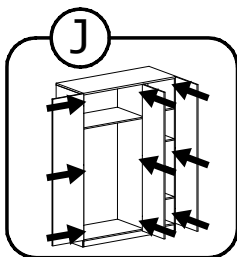
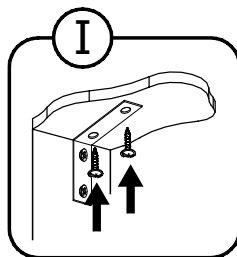
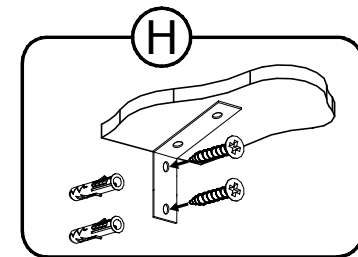
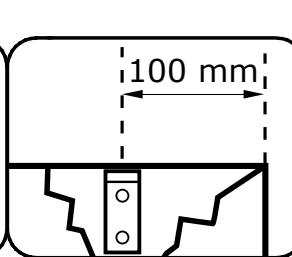
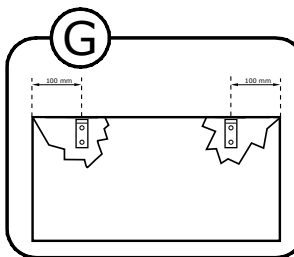
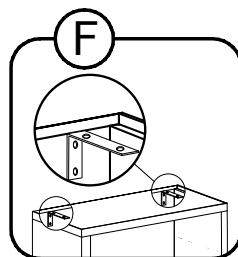
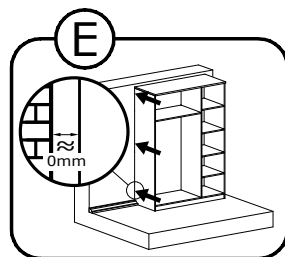
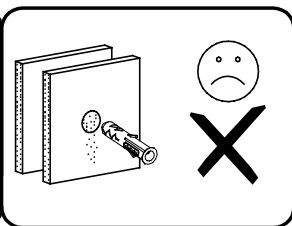
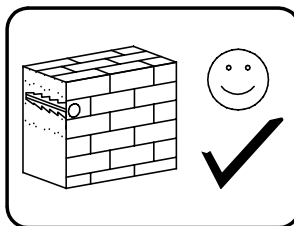
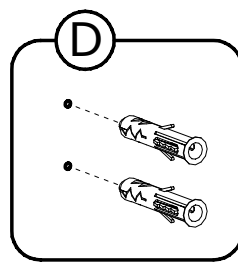
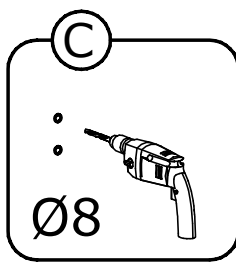
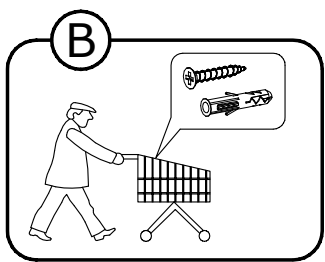
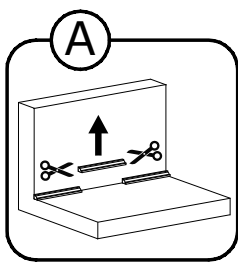
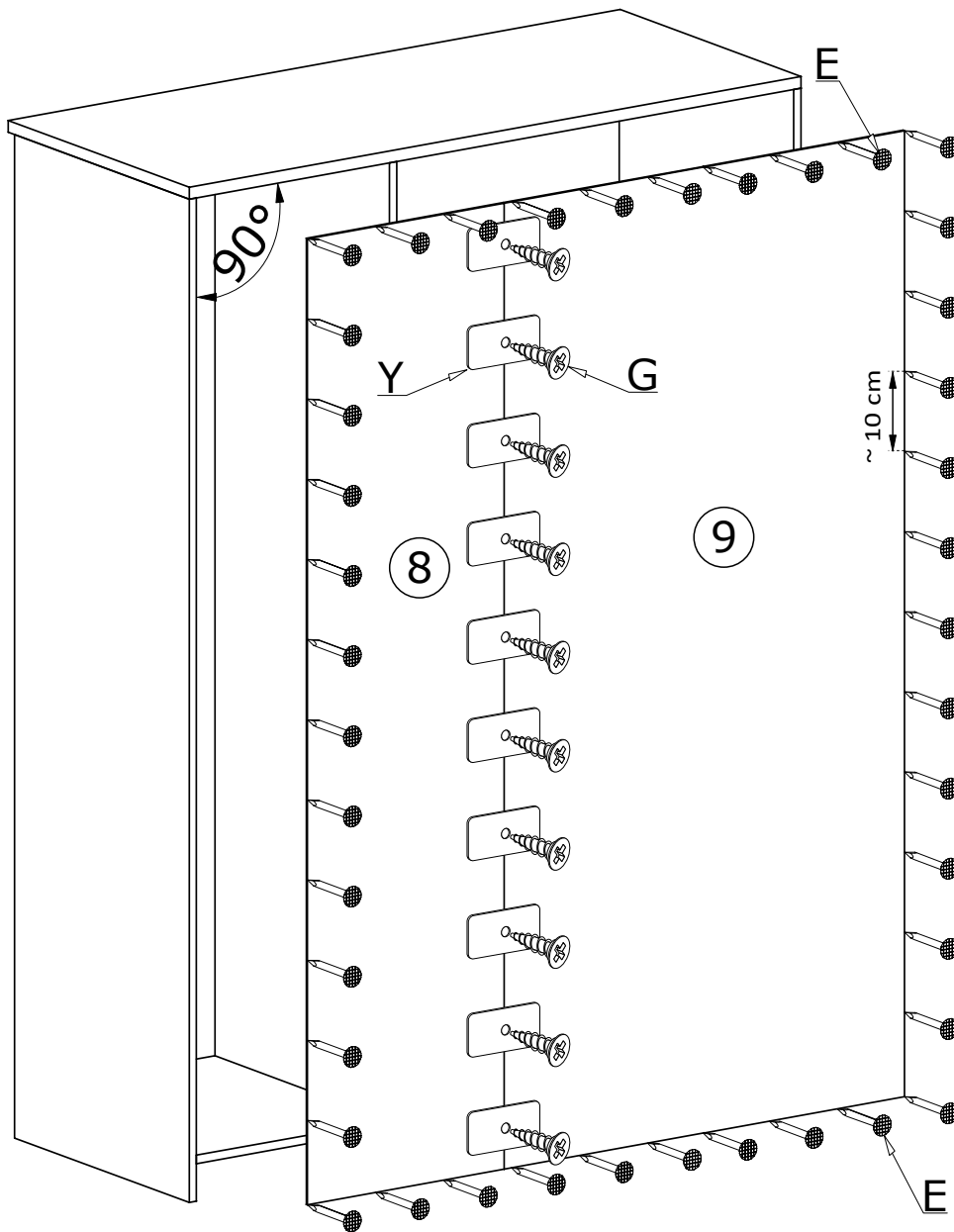

III

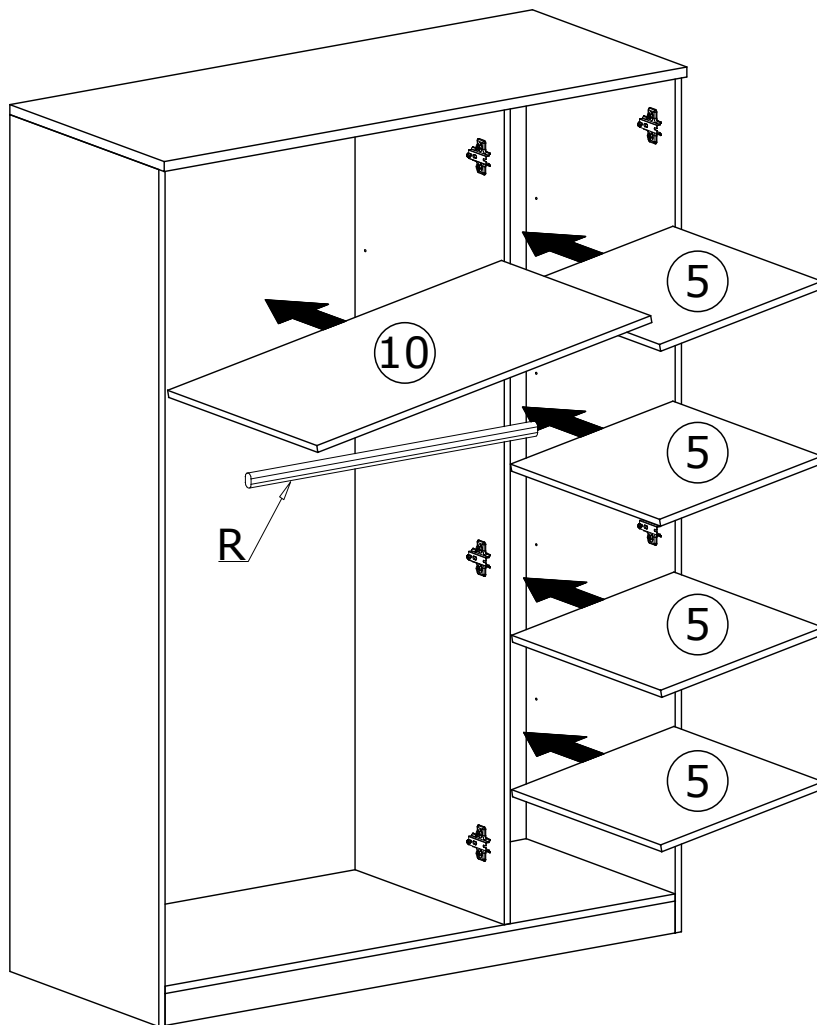

IV

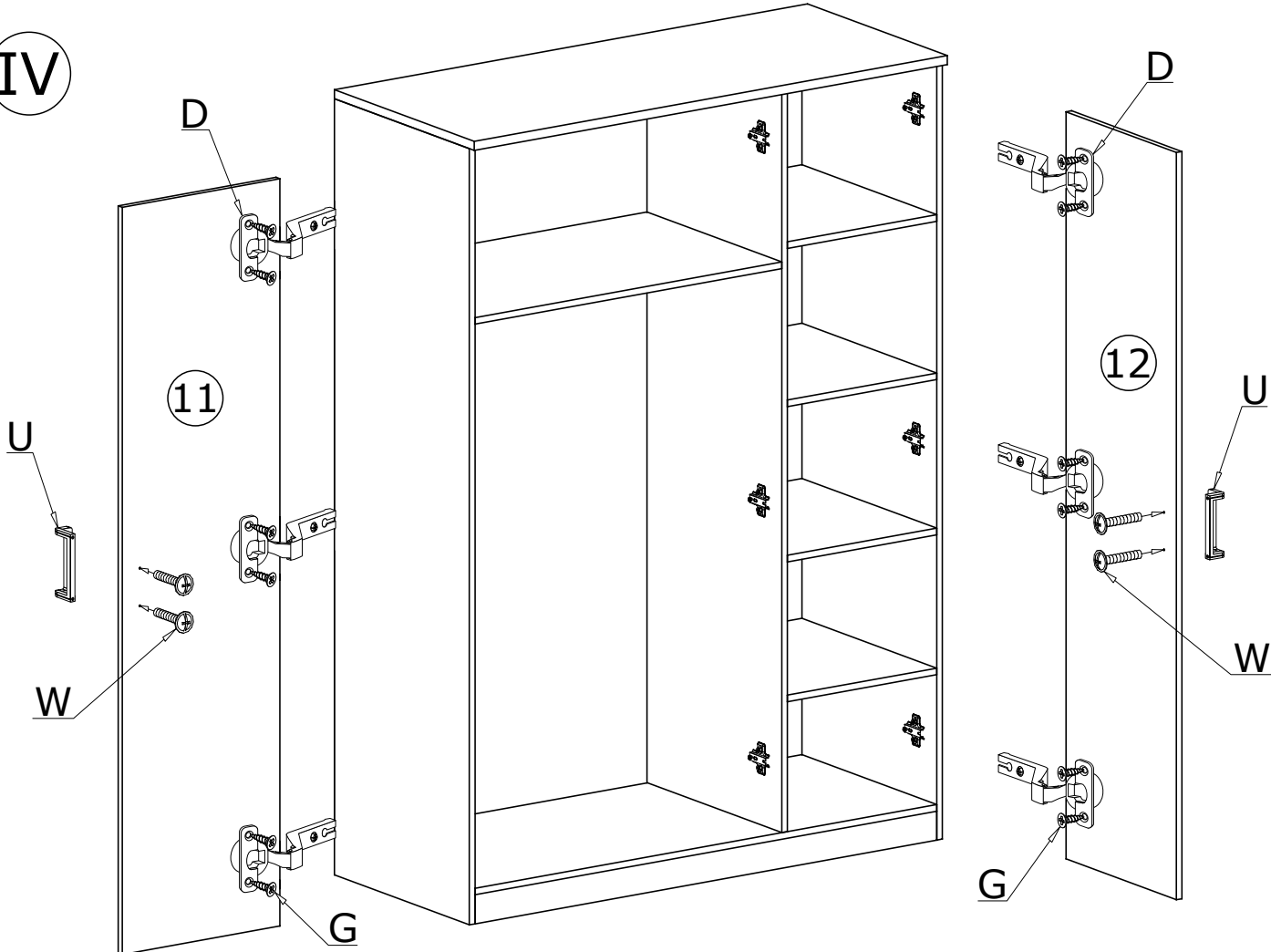

V

