

# TADEUSZ 24

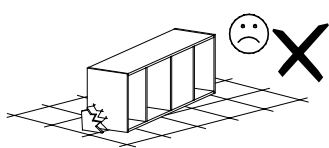

Narzędzia potrzebne do montażu

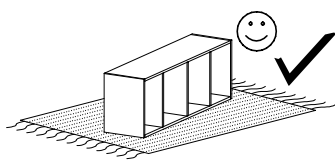
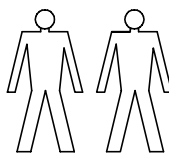
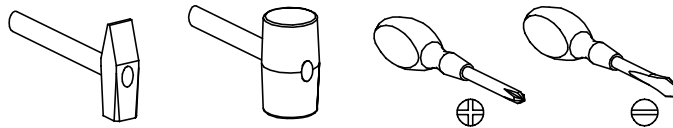

## UWAGA !!!

MONTOWANIE USZKODZONYCH  
ELEMENTÓW POWODUJE UTRATĘ  
GWARANCJI

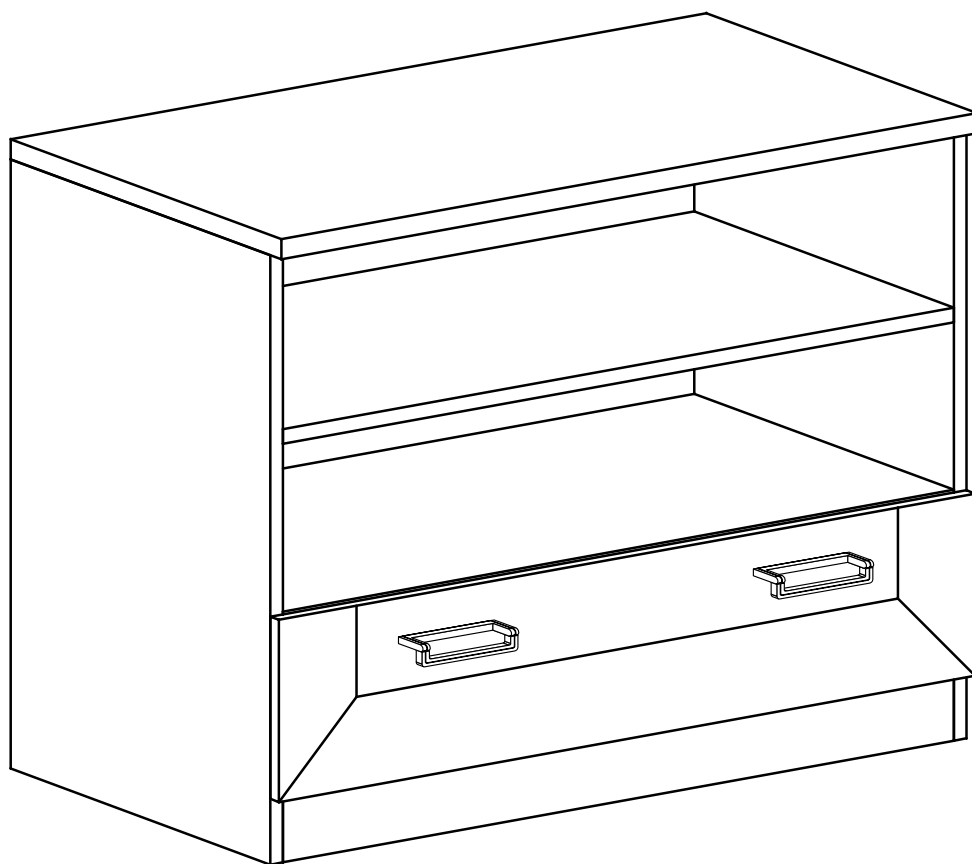

Nr	D[mm]	S[mm]	G[mm]	Ilość
1	880	495	32	1
2	832	460	16	1
3	832	460	16	1
4	660	460	16	1
5	660	460	16	1
6	832	80	16	1
7	832	460	16	1
8	775	150	16	1
9	450	150	16	1
10	450	150	16	1
11	862	190	16	1
12	805	455	2,5	1
13	855	607	2,5	1

W przypadku reklamacji proszę podać numer pakowacza znajdujący się na kartonie.



**X1 - 4 St.**

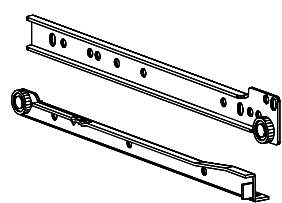

**T - 1 Kpl.**

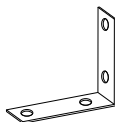

**Y - 2 St.**

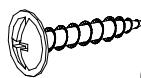

**Q - 4 St.**  
3,5x16 mm



**X2 - 8 St.**

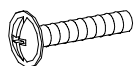

**N - 4 St.**  
4x25 mm



**U - 2 St.**

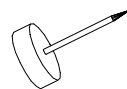

**Q - 5 St.**



**L - 6 St.**

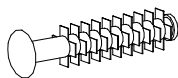

**F - 4 St.**



**E - 40 St.**



**M - 4 St.**  
4x25 mm

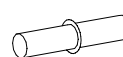

**P - 4 St.**



**S - 1 St.**

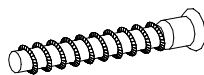

**R - 9 St.**



**B - 20 St.**

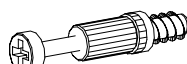

**K - 6 St.**

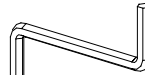

**Z - 1 St.**



**J - 4 St.**  
5x13 mm

I

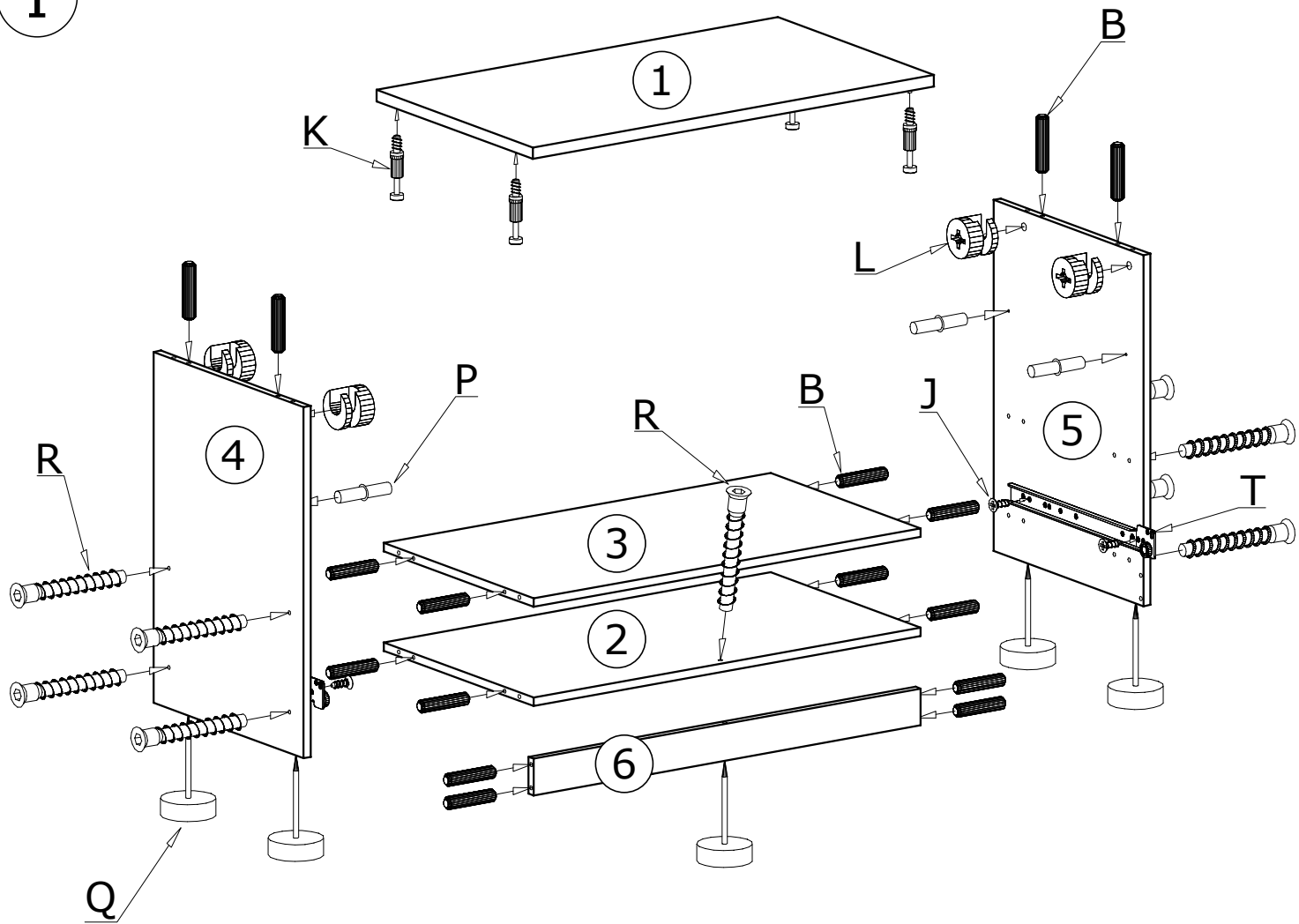

II

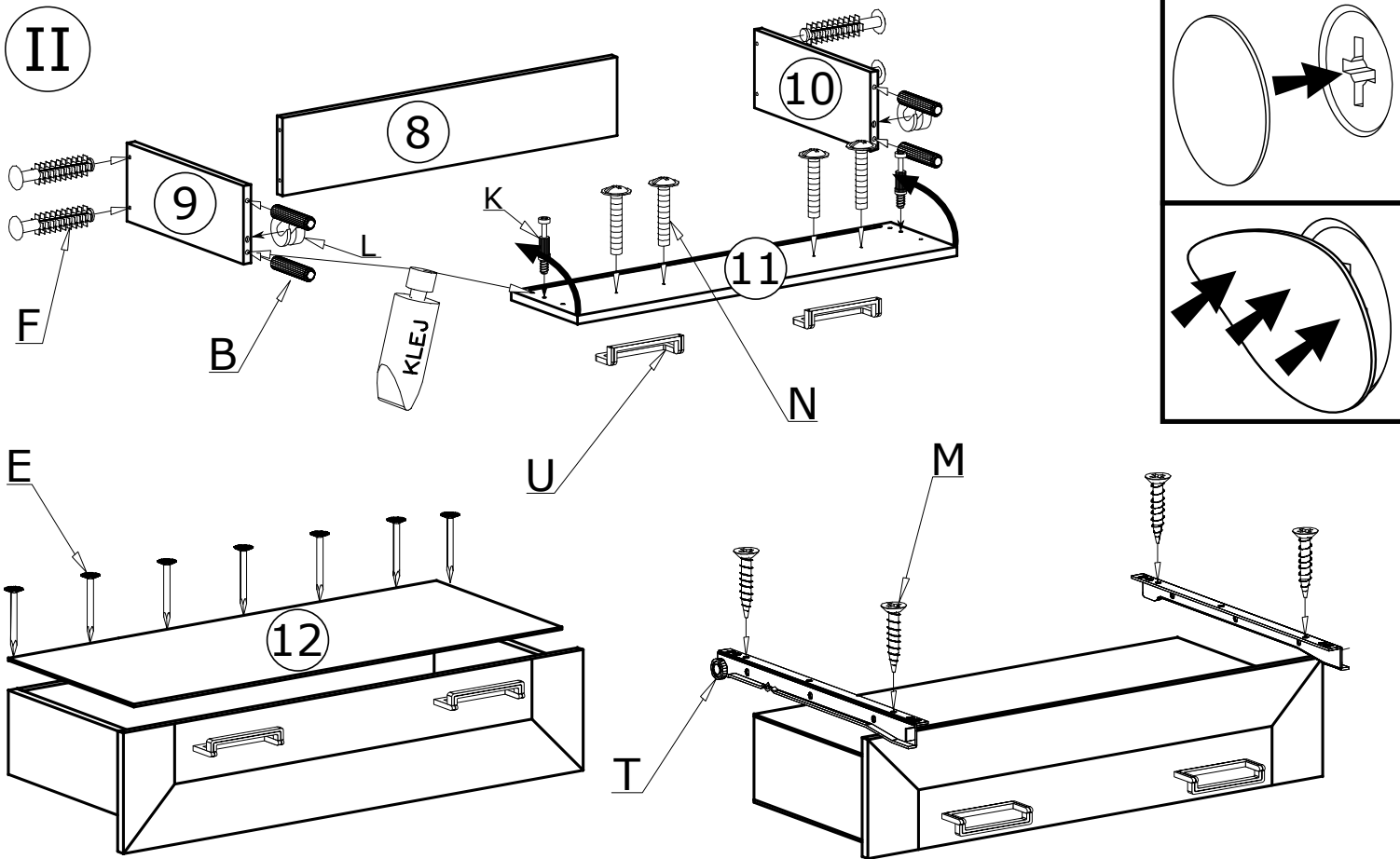

III

40X 

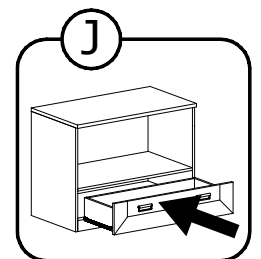
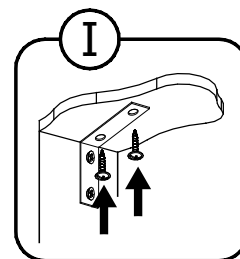
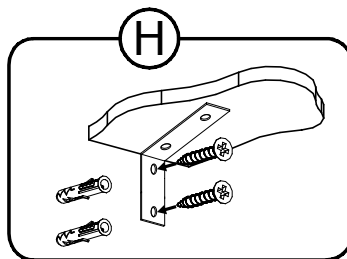
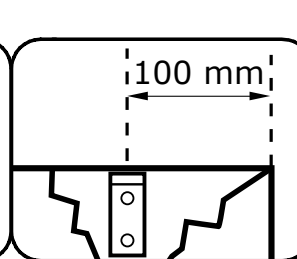
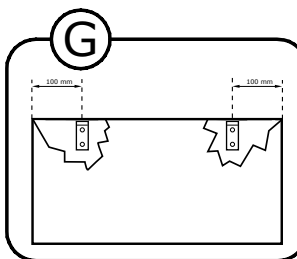
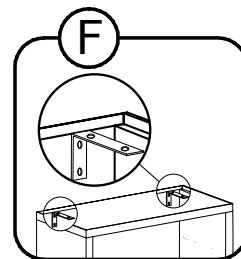
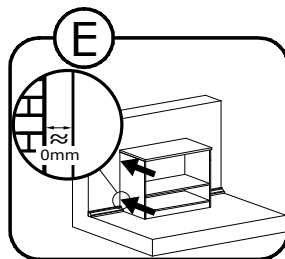
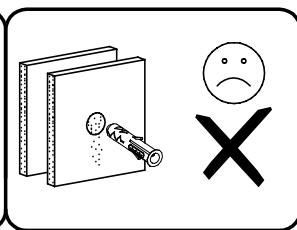
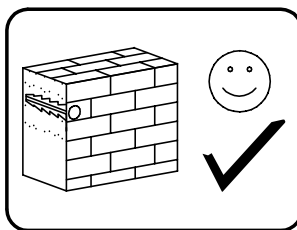
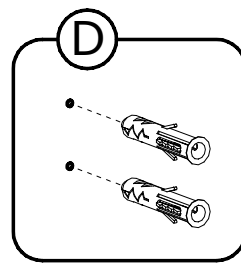
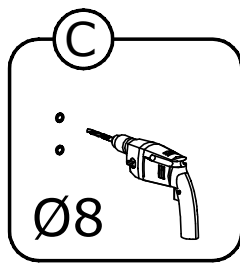
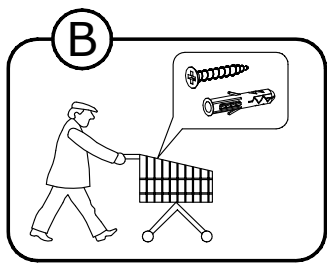
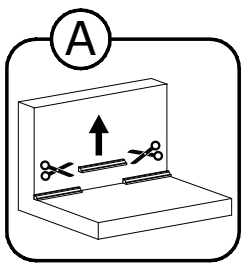
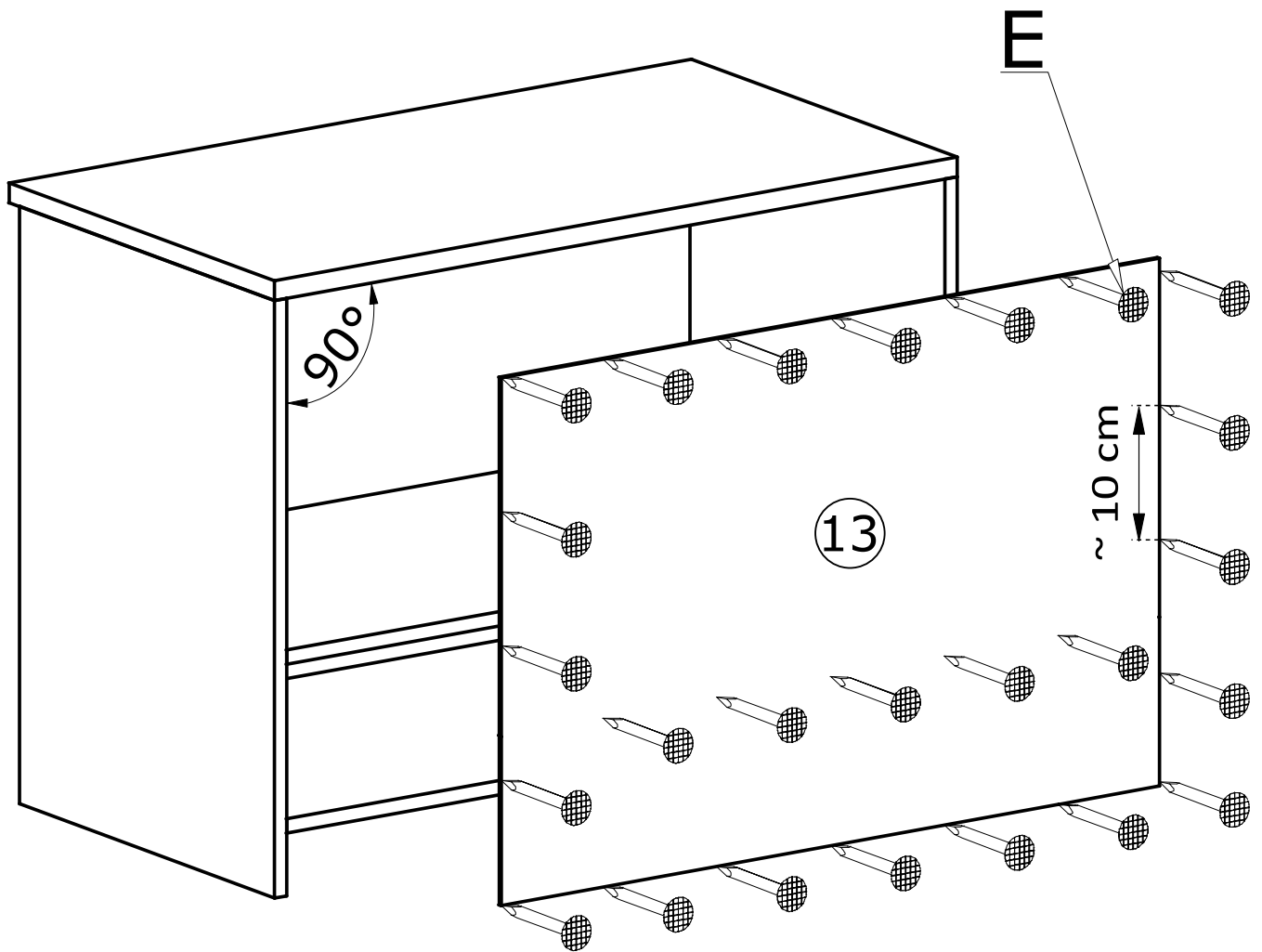

IV

