

VEGAS 23

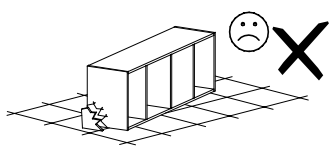

Narzędzia potrzebne do montażu

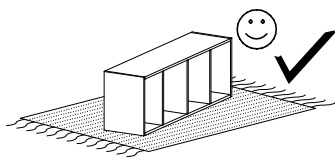
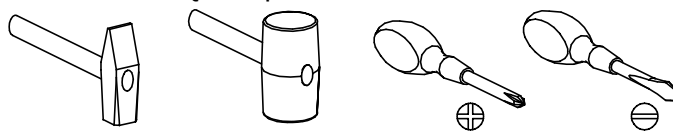

UWAGA !!!

MONTOWANIE USZKODZONYCH
ELEMENTÓW POWODUJE UTRATĘ
GWARANCJI

Nr	D[mm]	S[mm]	G[mm]	Ilość
1	1601	407	48	1
2	1601	407	48	1
3	403	405	48	1
4	400	388	16	1
5	400	388	16	1
6	403	405	48	1
7	342	320	16	2
8	845	388	16	1
9	1590	458	2,5	1
10	316	392	16	1
11	316	392	16	1
12	855	190	16	1
13	350	165	16	1
14	350	165	16	1
15	787	165	16	1
16	818	355	2,5	1

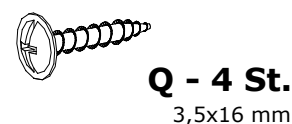
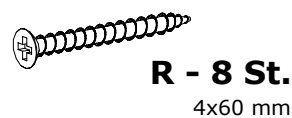
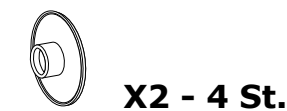
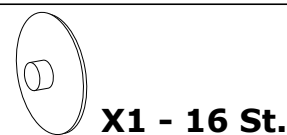
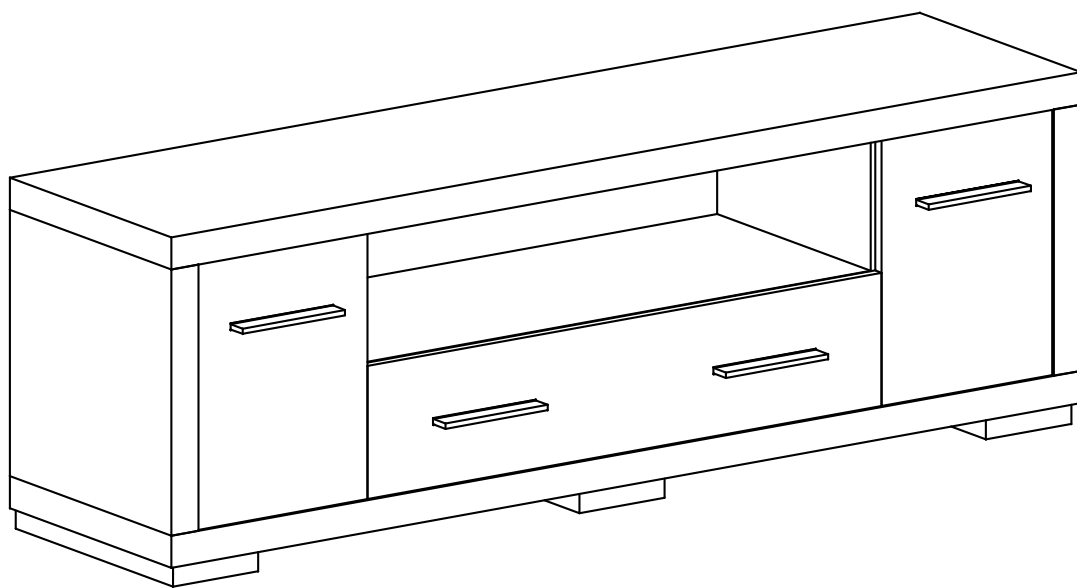

W przypadku reklamacji proszę podać numer pakowacza znajdujący się na kartonie.

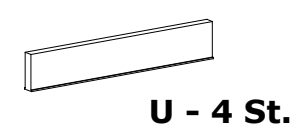
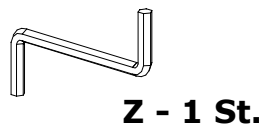
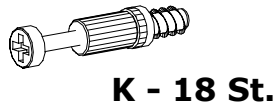
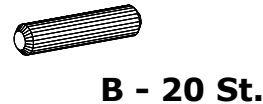
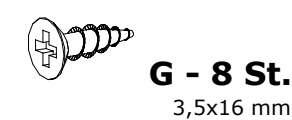
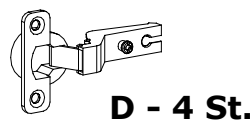
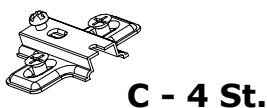
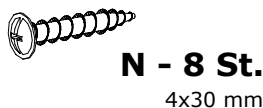
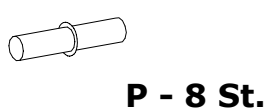
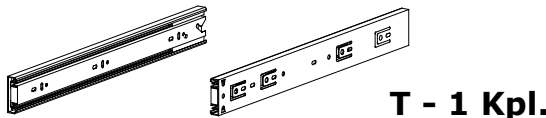
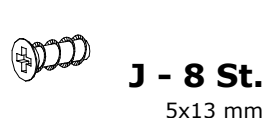
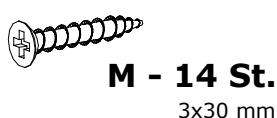
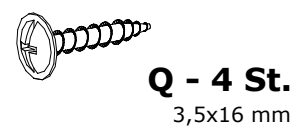
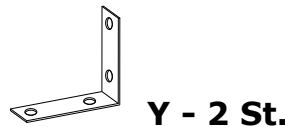
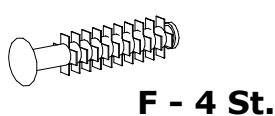
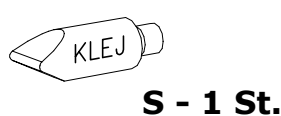
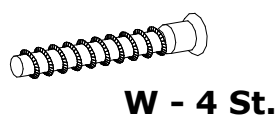

I

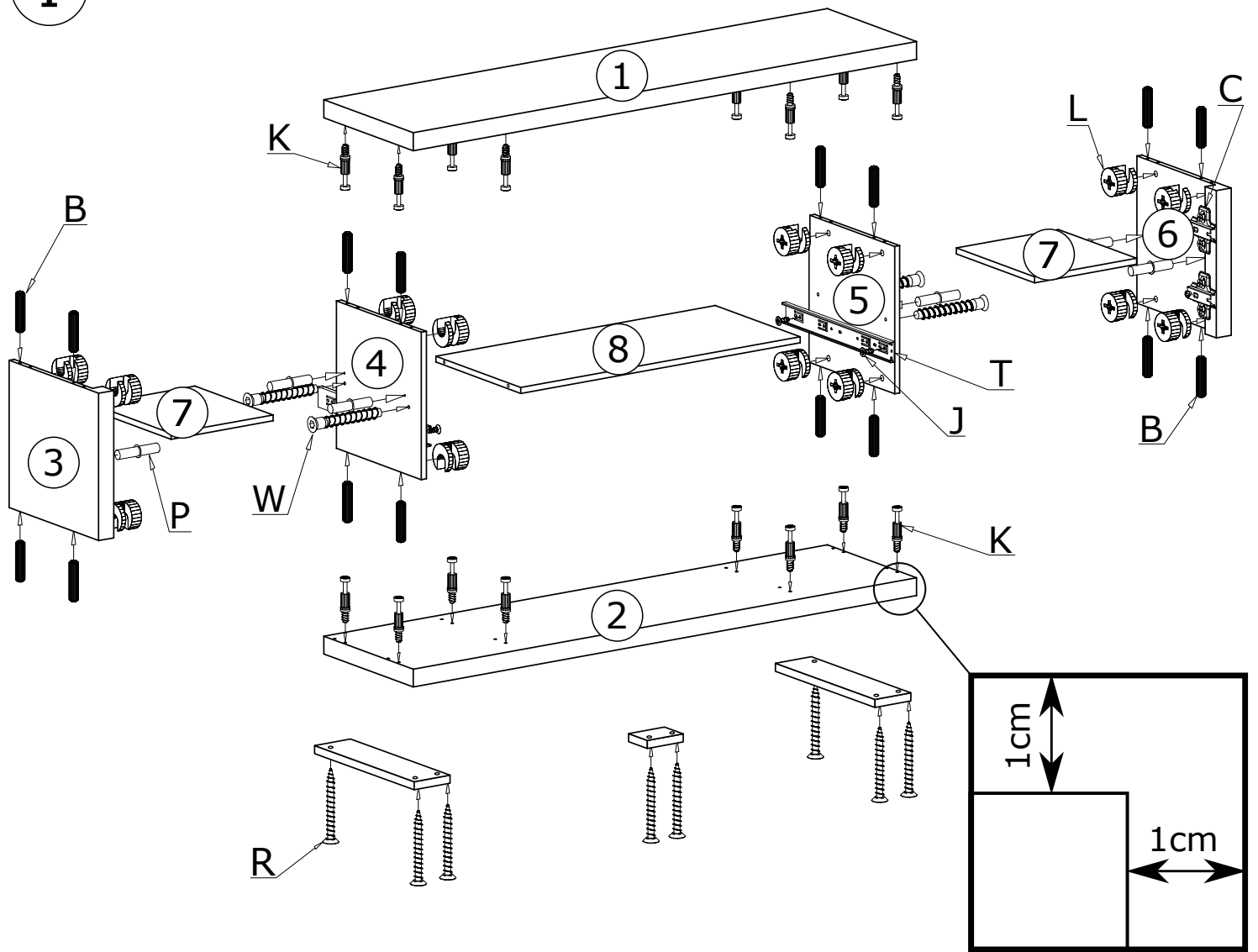

II

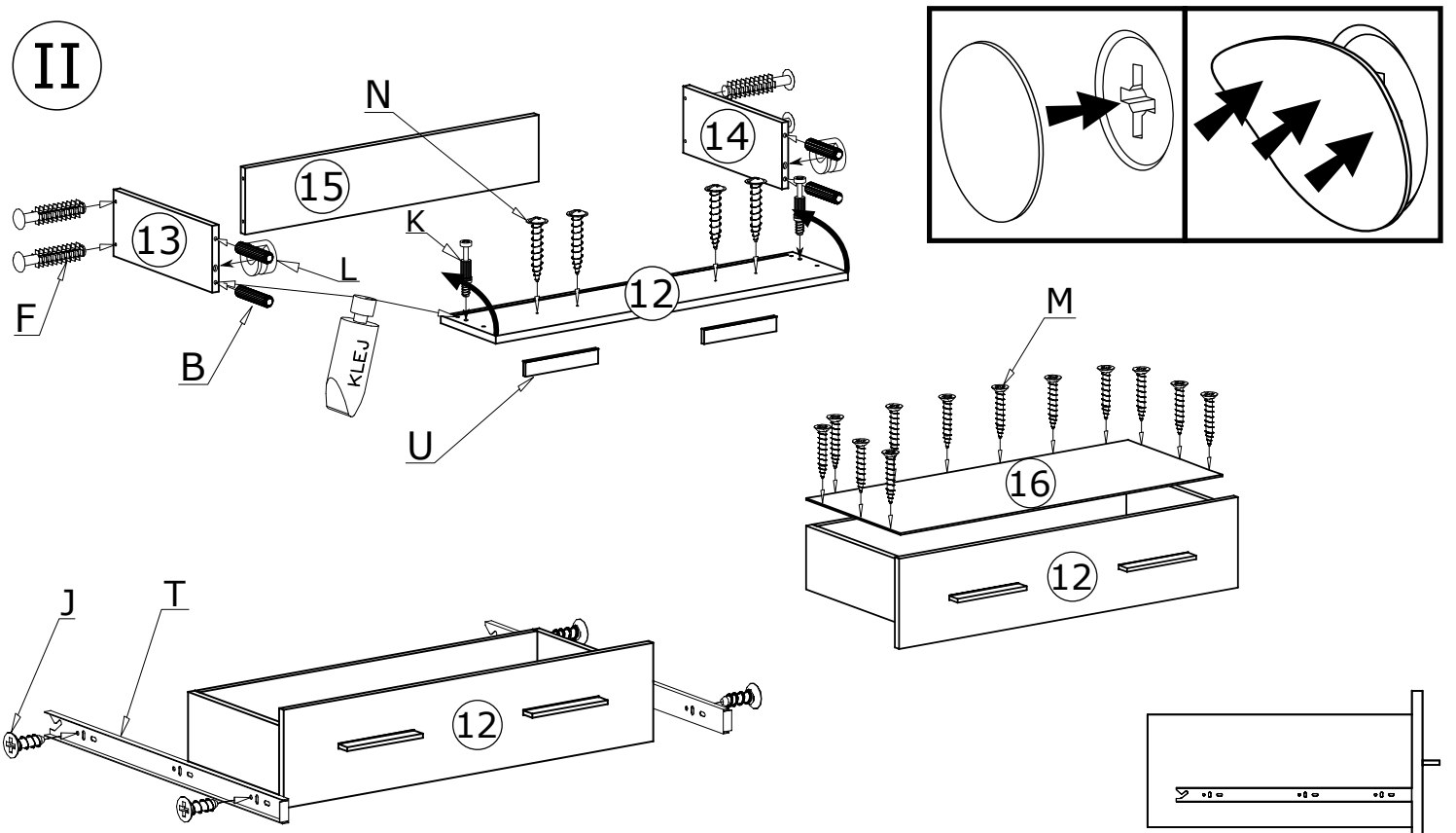

III

50X 

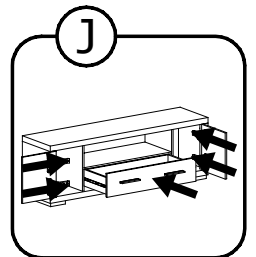
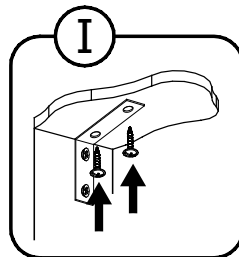
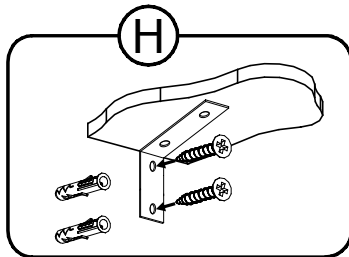
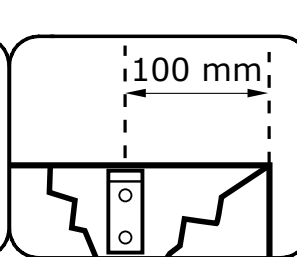
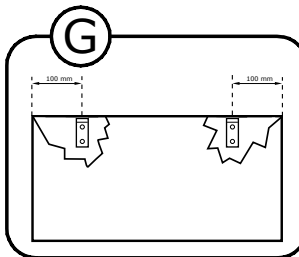
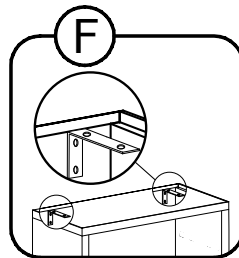
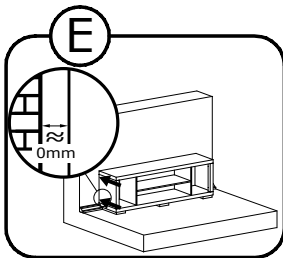
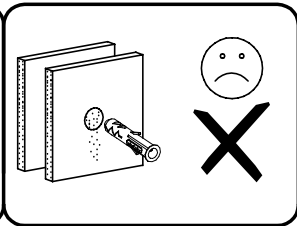
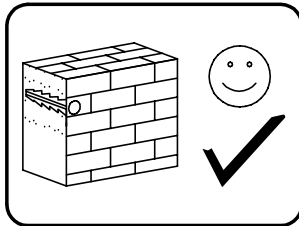
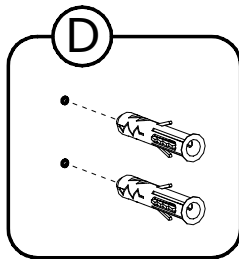
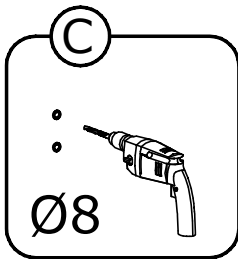
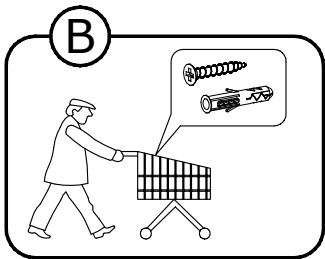
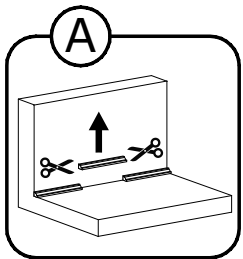
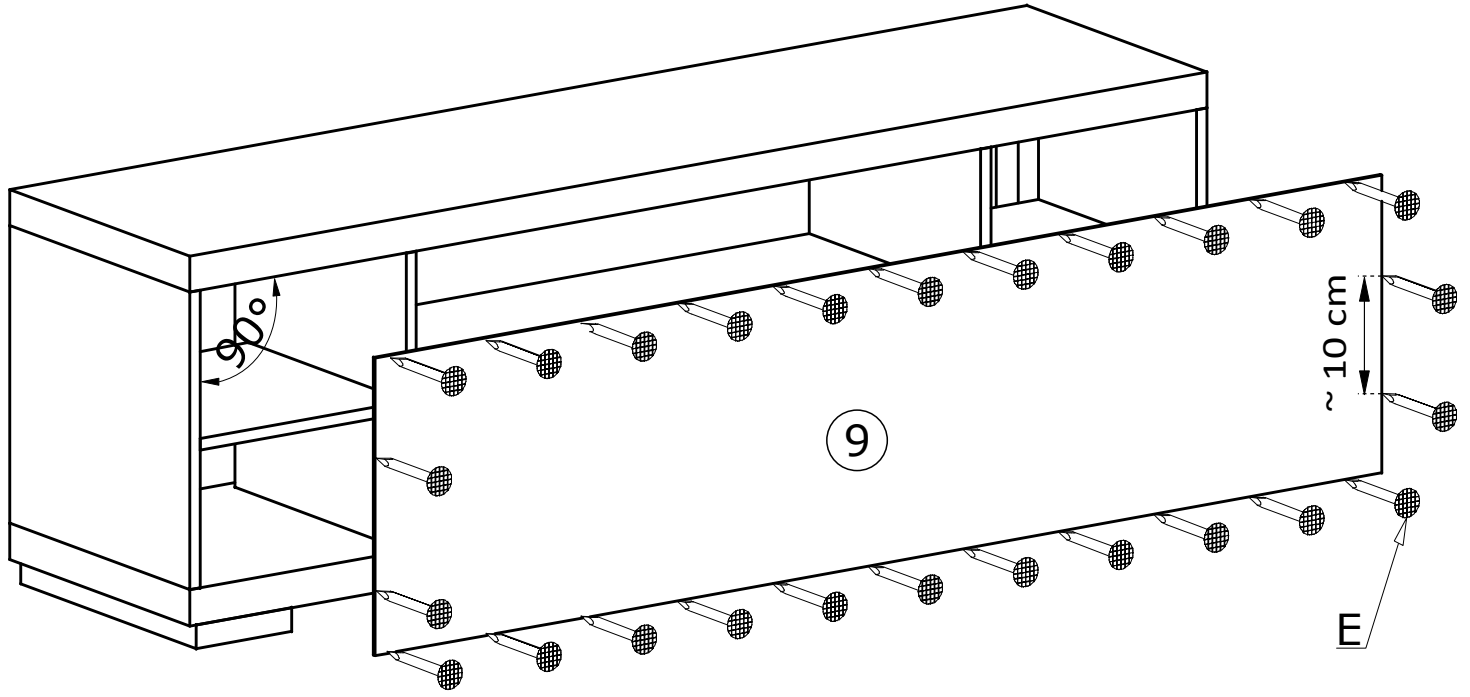

IV

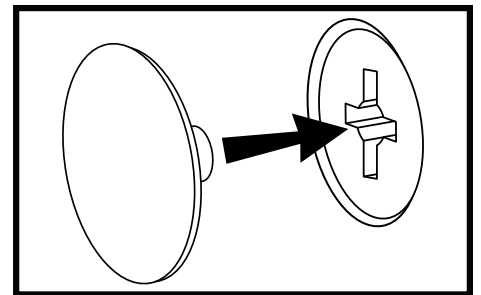
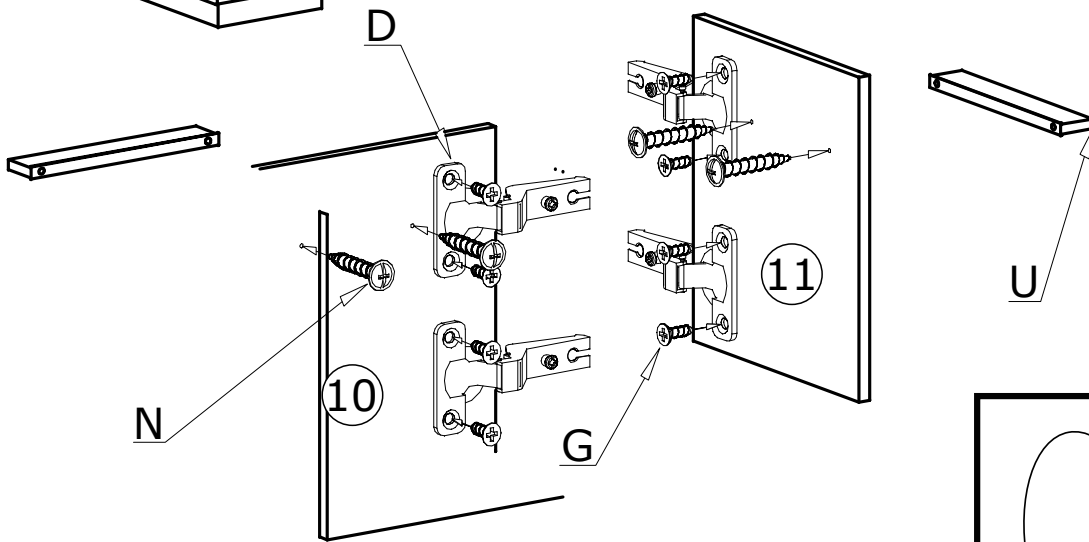
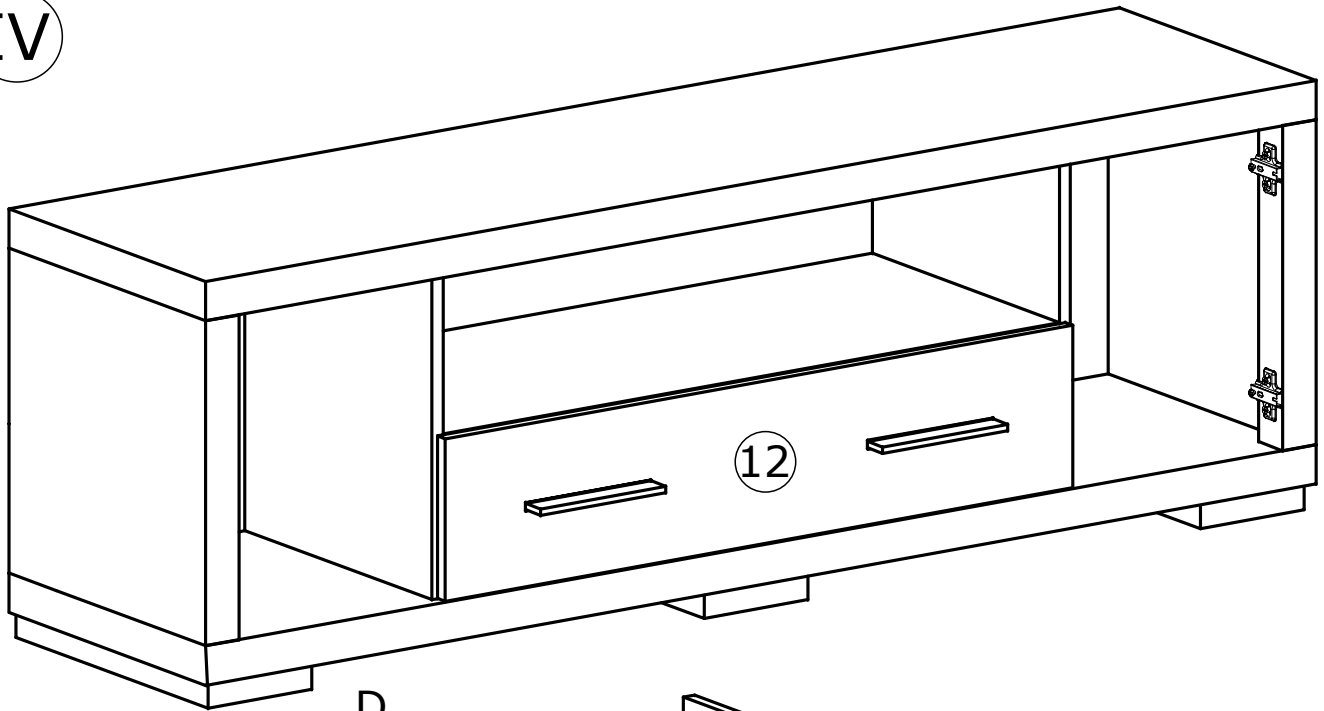

MONTAŻ/DEMONTAŻ PROWADNIC

1



2

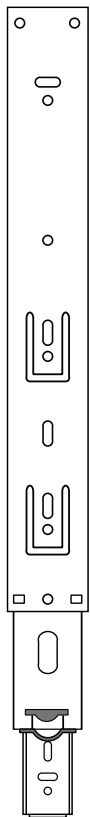

3

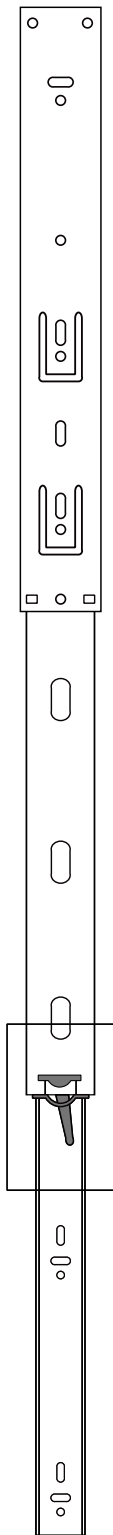

4

