

# VEGAS 28

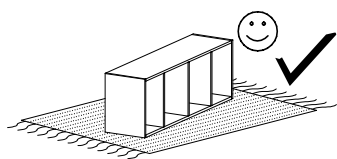

Narzędzia potrzebne do montażu

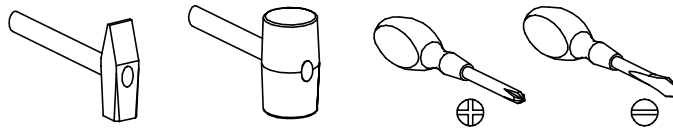

## UWAGA !!!

MONTOWANIE USZKODZONYCH  
ELEMENTÓW POWODUJE UTRATĘ  
GWARANCJI

Nr	D[mm]	S[mm]	G[mm]	Ilość
1	1201	602	48	1
2	727	550	48	1
3	649	550	48	1
4	649	550	48	1
5	501	552	48	1
6	653	200	16	1
7	646	465	16	1
8	627	350	16	1
9	344	107	16	1
10	500	107	16	1
11	505	375	2,5	1
12	395	156	16	1
13	500	107	16	1

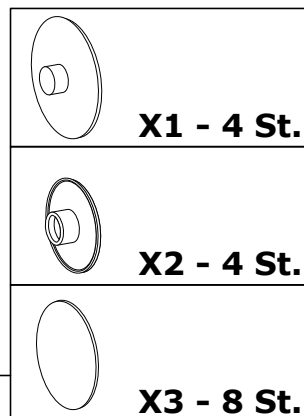
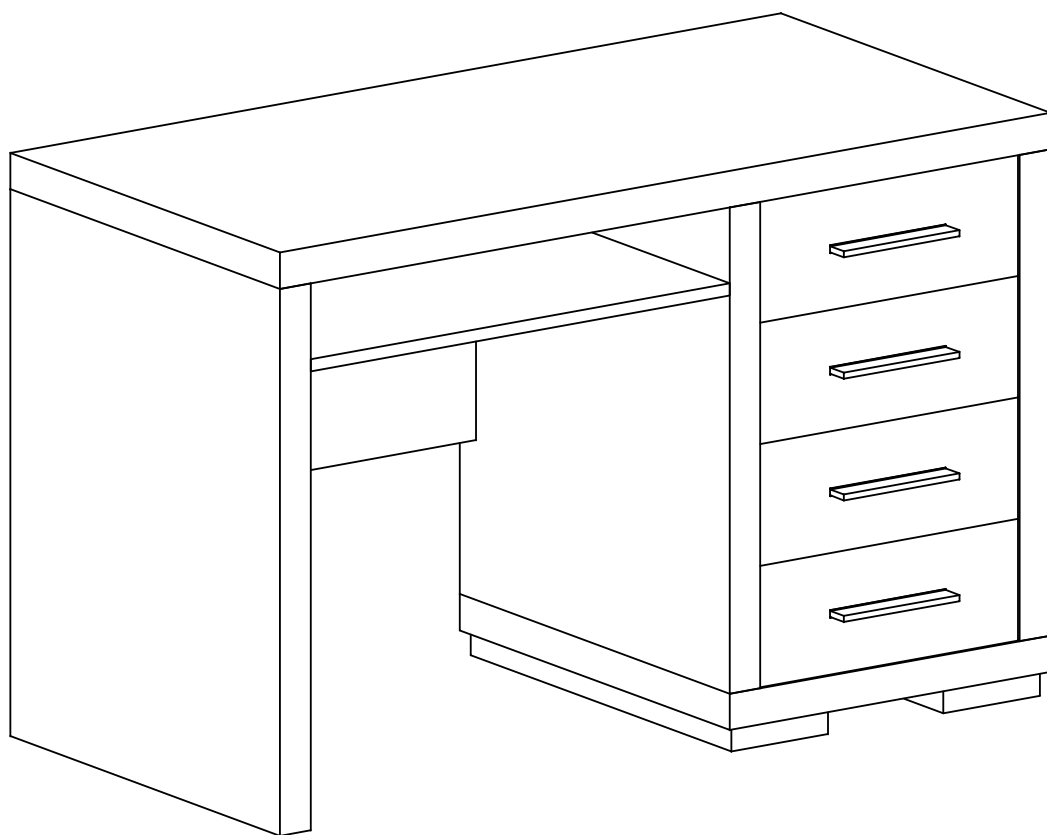

**X1 - 4 St.**

**X2 - 4 St.**

**X3 - 8 St.**

W przypadku reklamacji proszę podać numer pakowacza znajdujący się na kartonie.

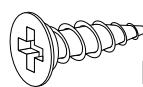

**D - 4 St.**  
3,5x16 mm



**Q - 2 St.**

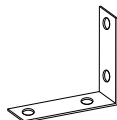

**Y - 2 St.**

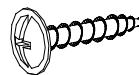

**I - 4 St.**  
3,5x16 mm

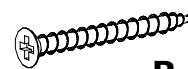

**R - 6 St.**  
4x60 mm

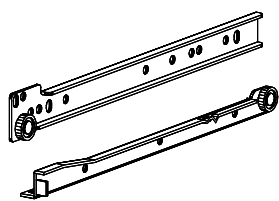

**A - 1 Kpl.**

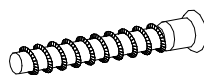

**W - 6 St.**



**M - 80 St.**  
3x30 mm



**N - 8 St.**  
4x30 mm



**L - 20 St.**



**B - 28 St.**



**U - 4 St.**

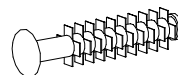

**F - 16 St.**



**S - 1 St.**

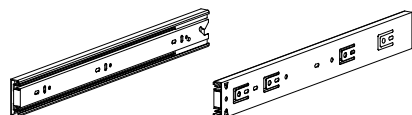

**T - 4 Kpl.**

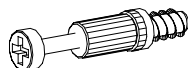

**K - 20 St.**

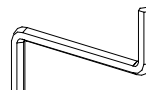

**Z - 1 St.**



**J - 36 St.**  
5x13 mm

I

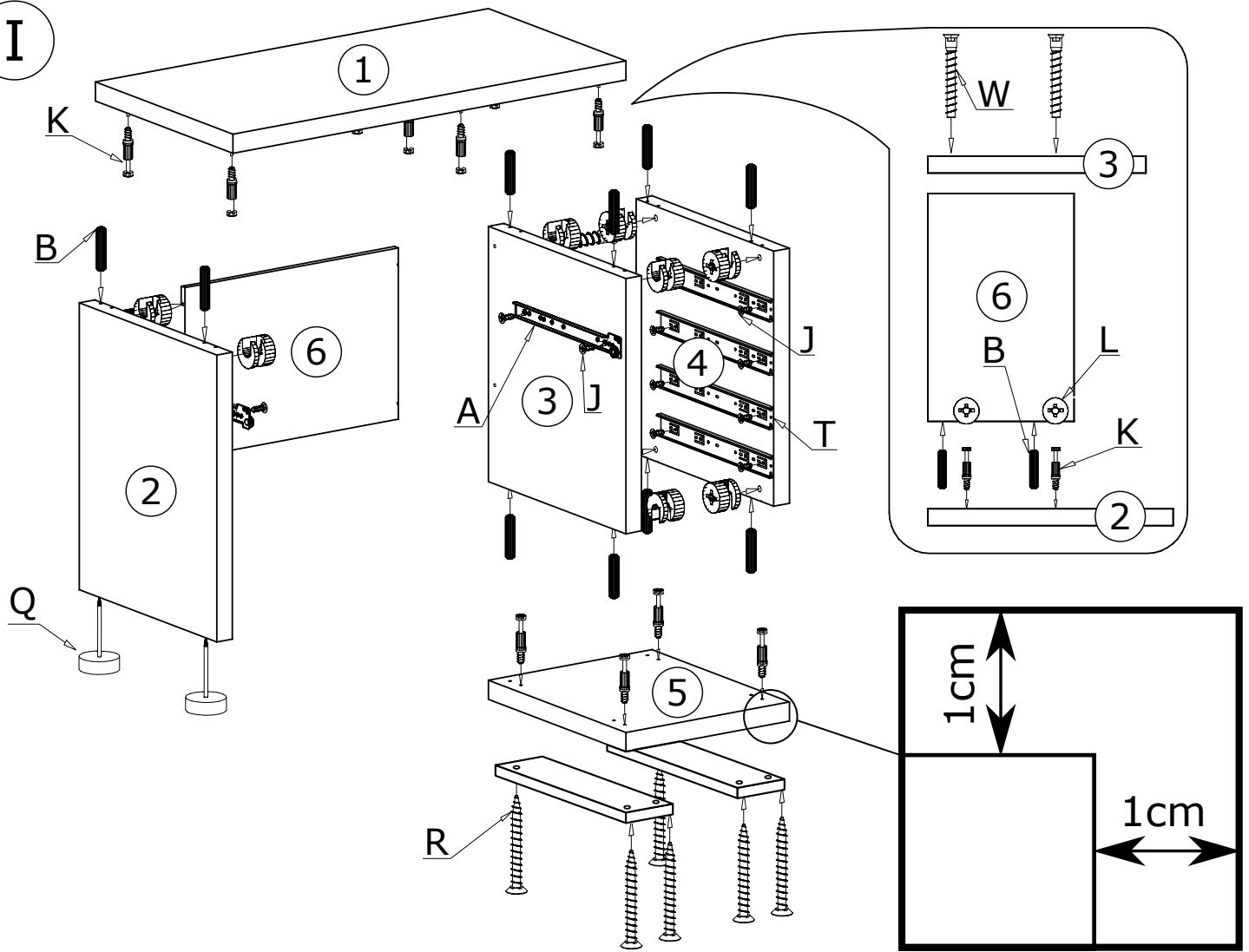

II

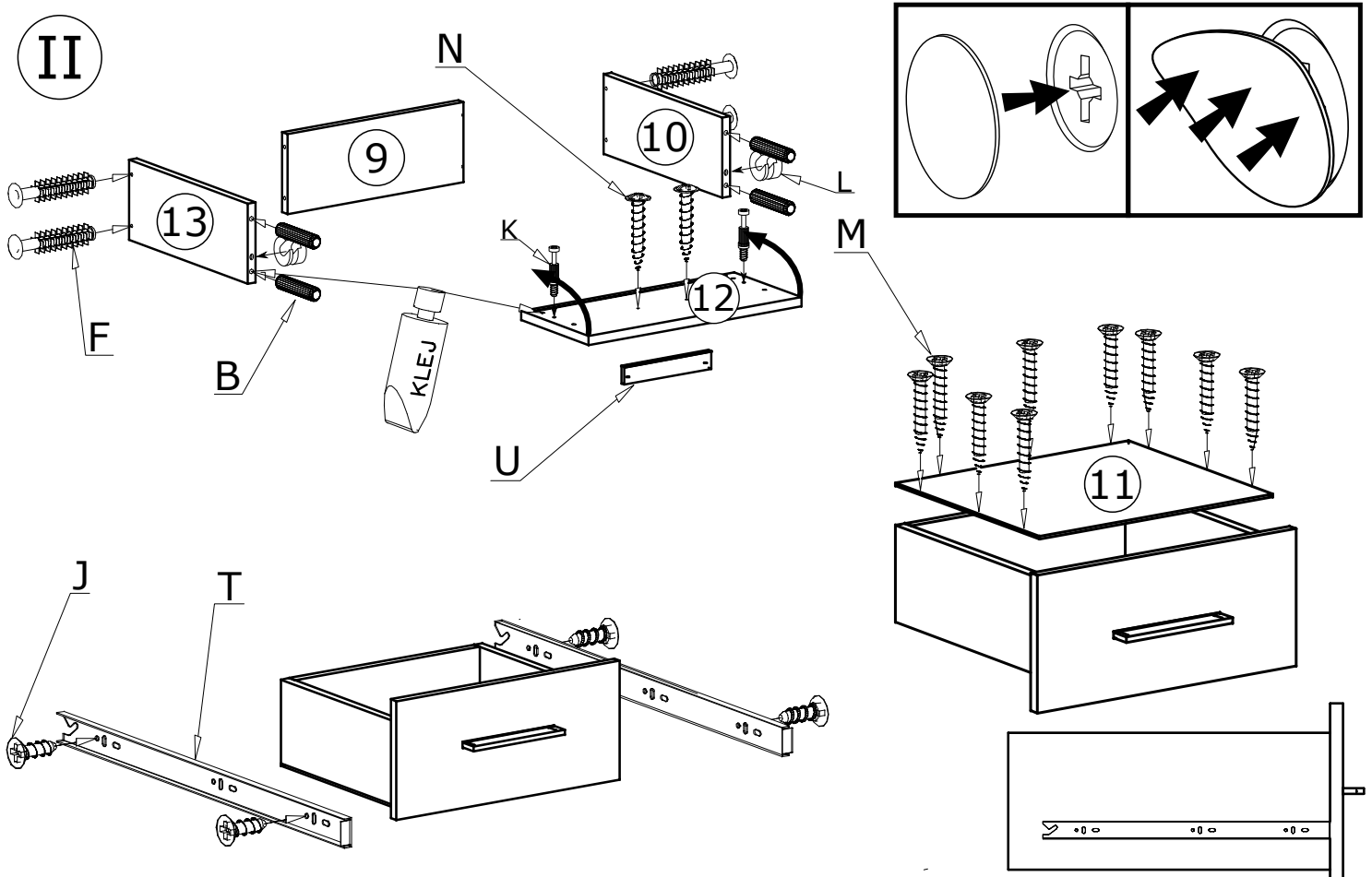

III

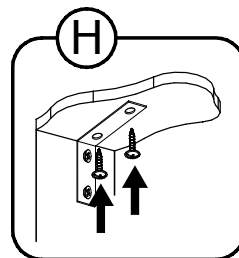
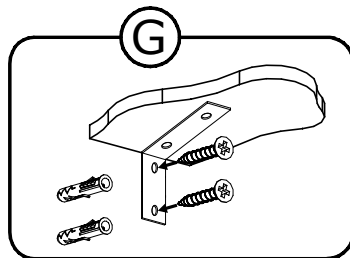
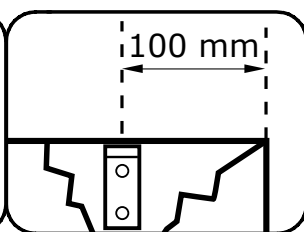
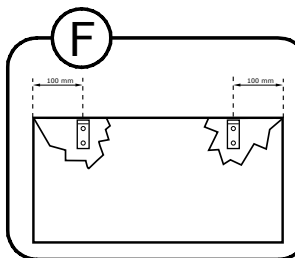
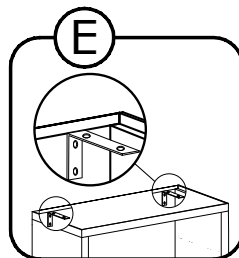
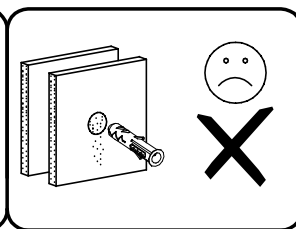
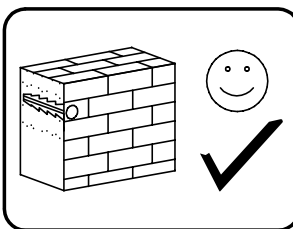
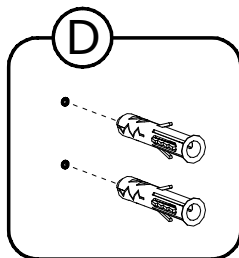
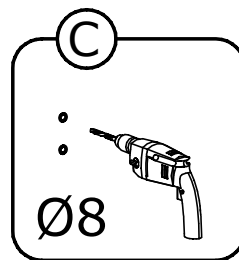
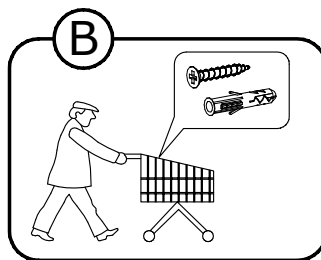
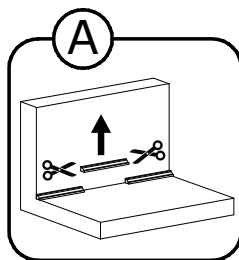
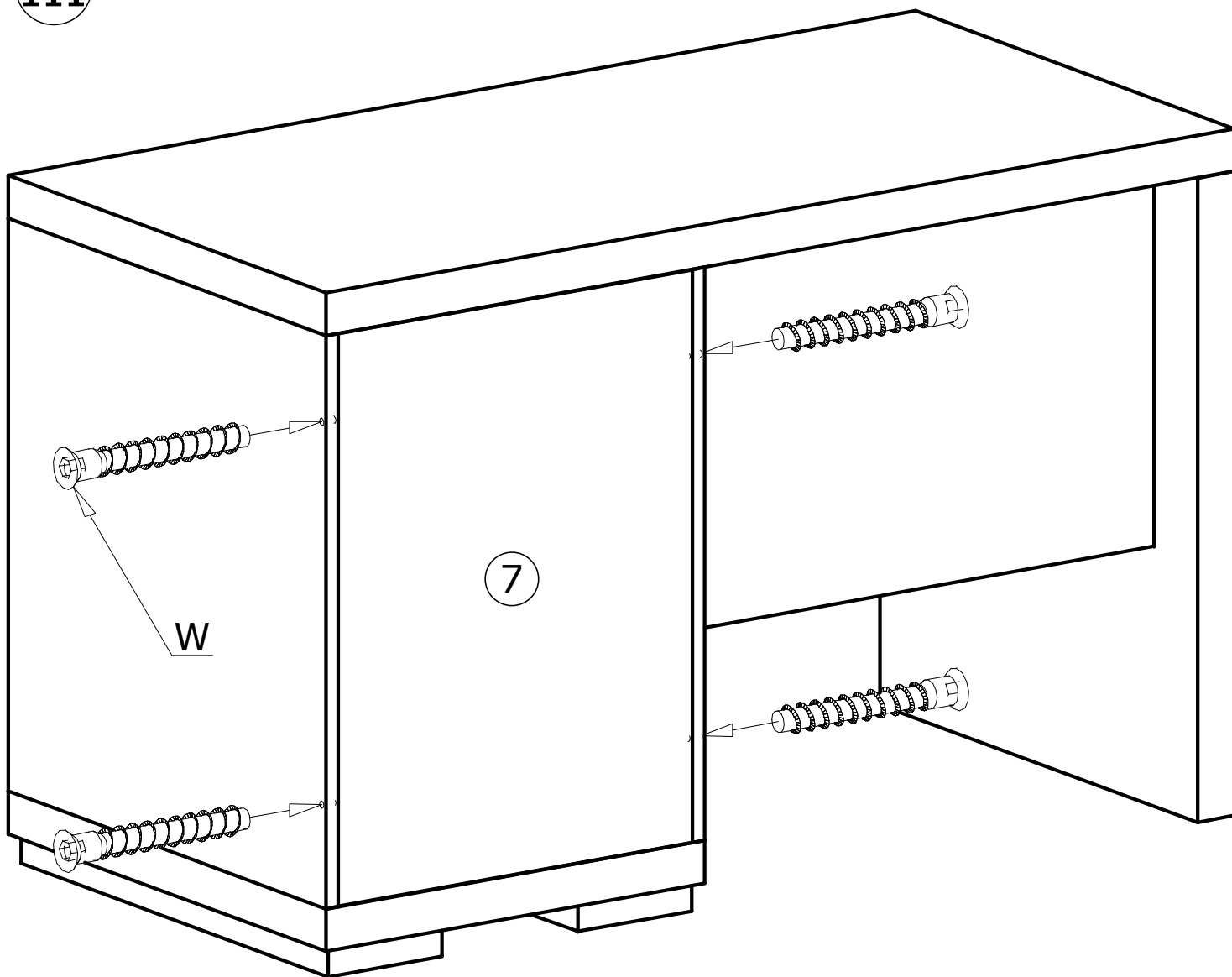

IV

