

# SANTIAGO SN 5

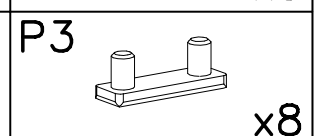

I

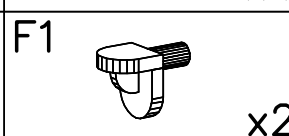
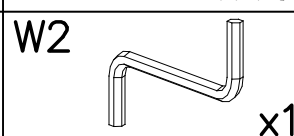
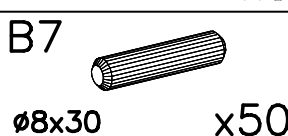
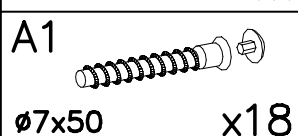
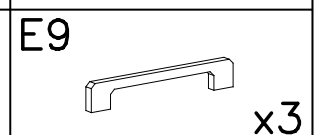
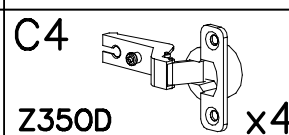
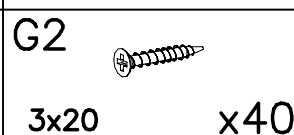
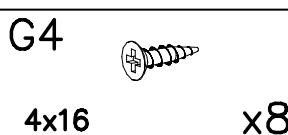
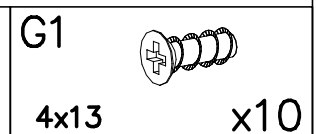
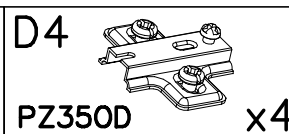
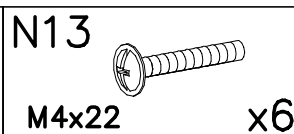
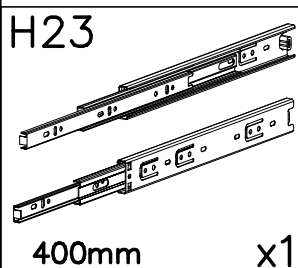
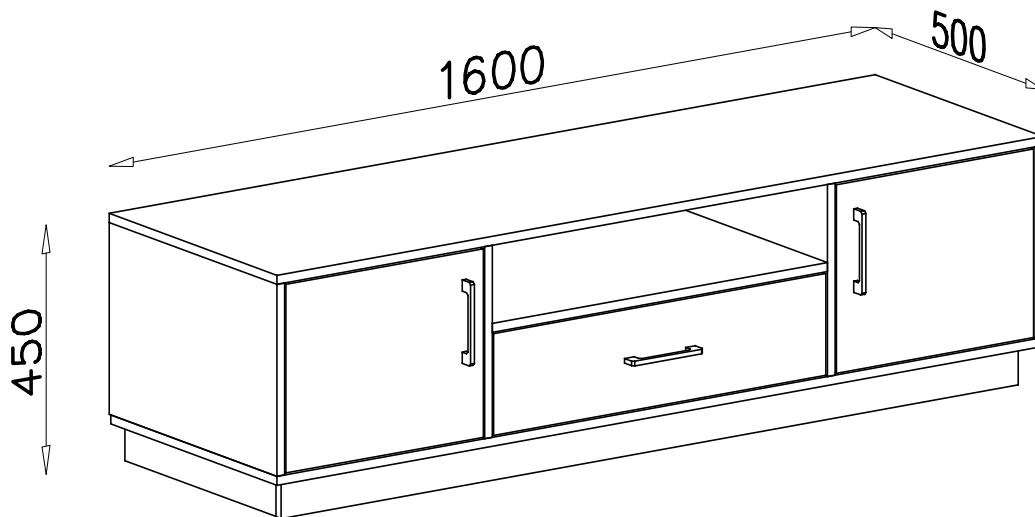
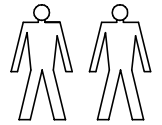
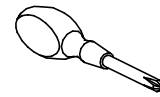
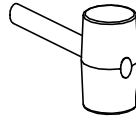
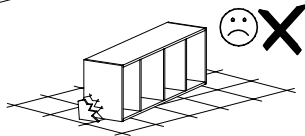
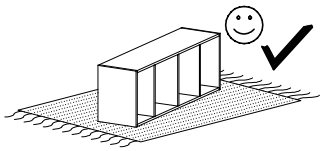
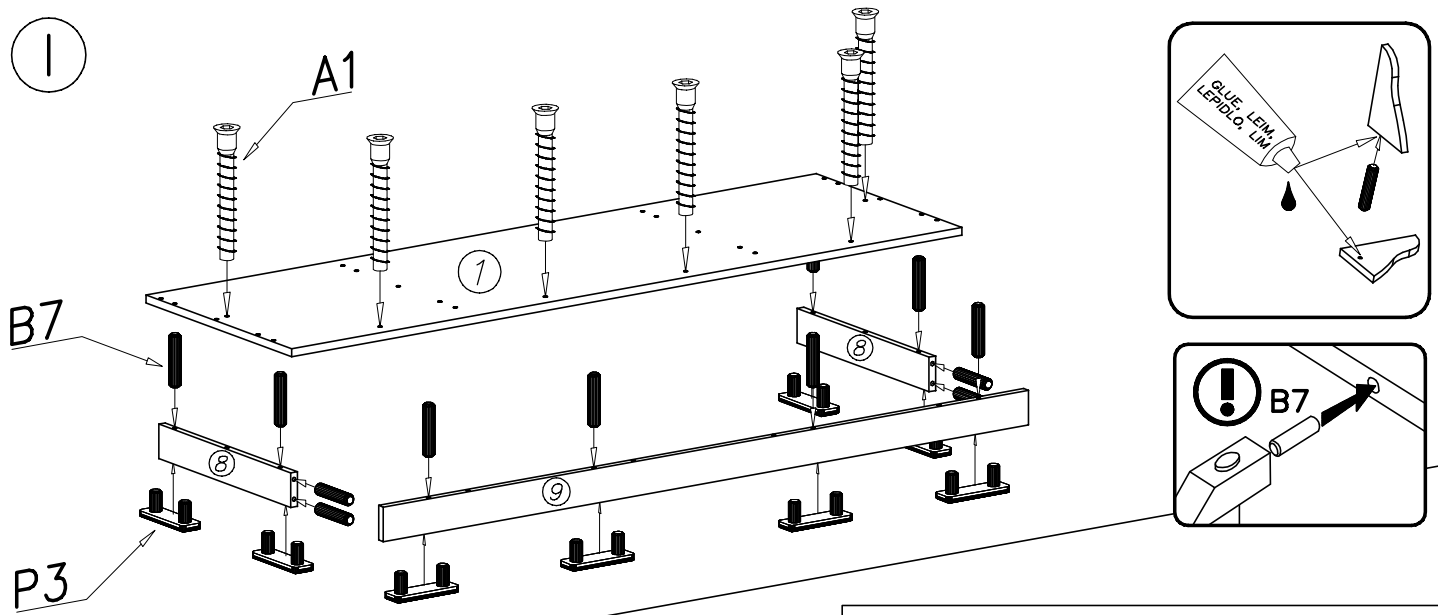

II

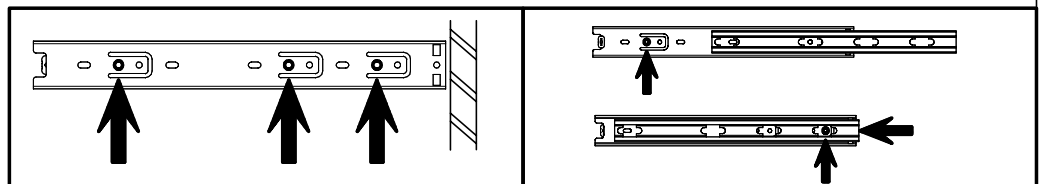
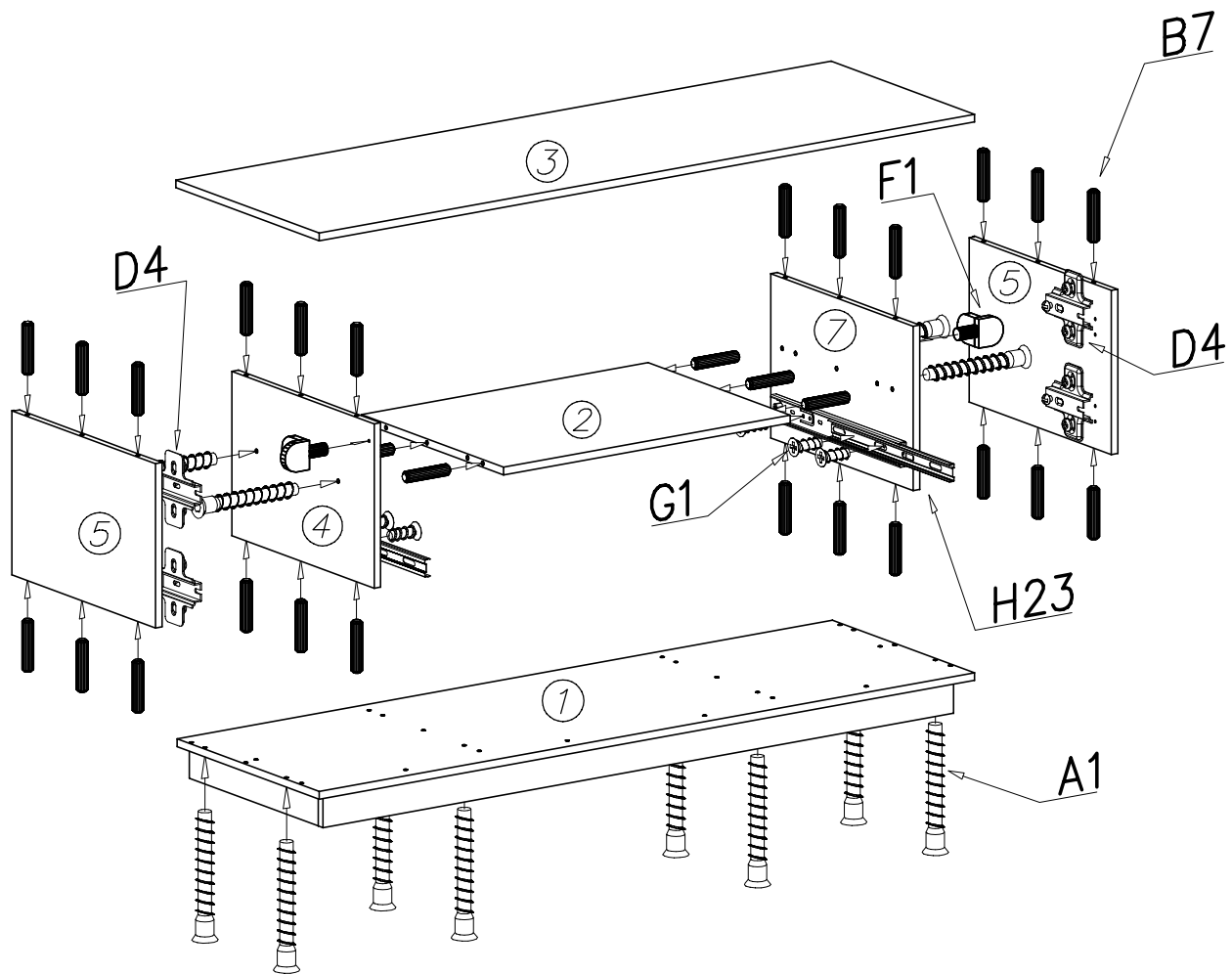
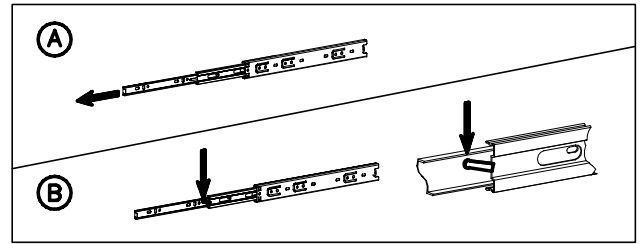

III

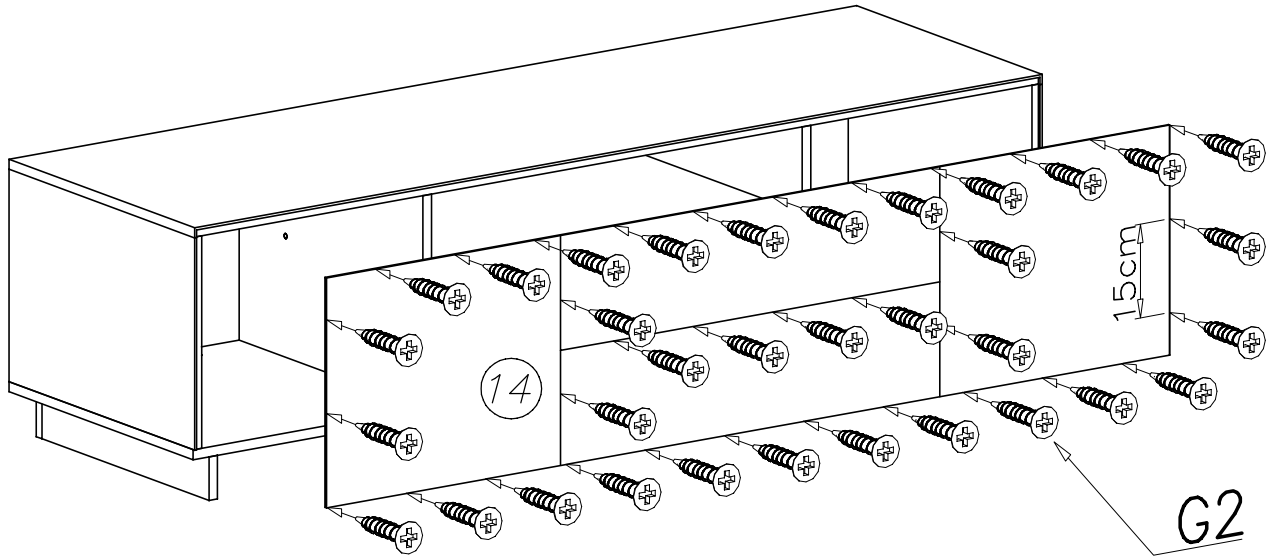

IV

